

# Orientalmotor

## $\alpha$ STEP AZ Series Connector Type

Built-in Battery-Free Absolute Sensor

The same features of AZ Series,  
but now with a single cable.

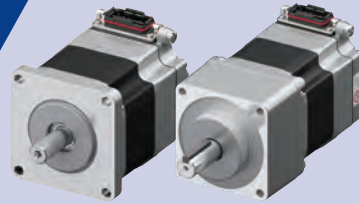

Standard Type

**NEW** Geared Type



EtherCAT EtherNet/IP PROFINET MECHATROLINK SSCNET III/H Modbus (RTU)

### Direct Connection of Motor and Driver

Without an extension cable, a connection of up to 10 m is possible. No extension cable is required.

The wiring process is more efficient thanks to the power line, signal line, electromagnetic brake line and ground wire all being consolidated into one cable.

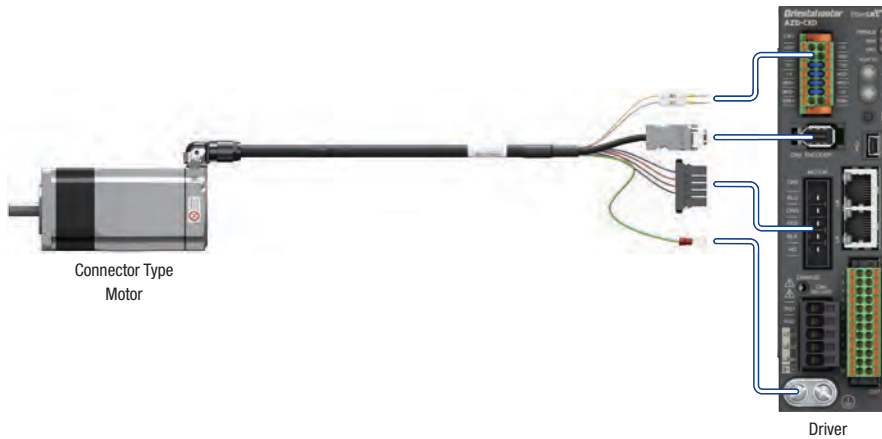

### Lock Lever Connector for Simple Connection

Connecting the cable is easy due to the lock lever that does not require screws.



### Three Cable Outlet Directions Can be Selected

Select from three cable outlet directions. This increases the degree of cable outlet freedom around the motor.

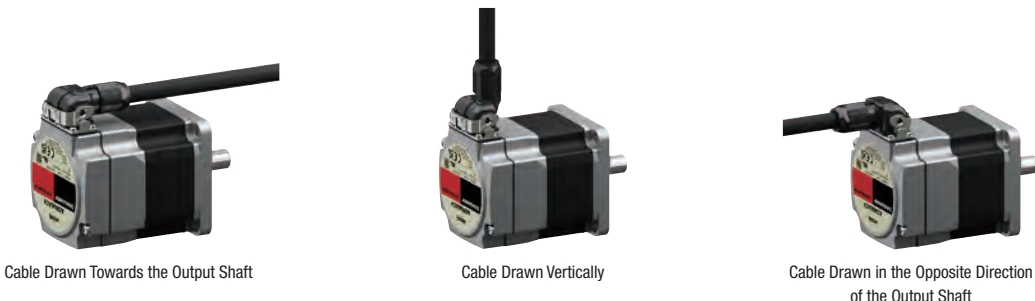

# Use of a Single Cable Reduces Routing Work and Smaller Cable Holders

## Conventional Product (Cable type)

Z-axis (Electromagnetic brake motor): 3 cables  
Y-axis (Standard motor) : 2 cables

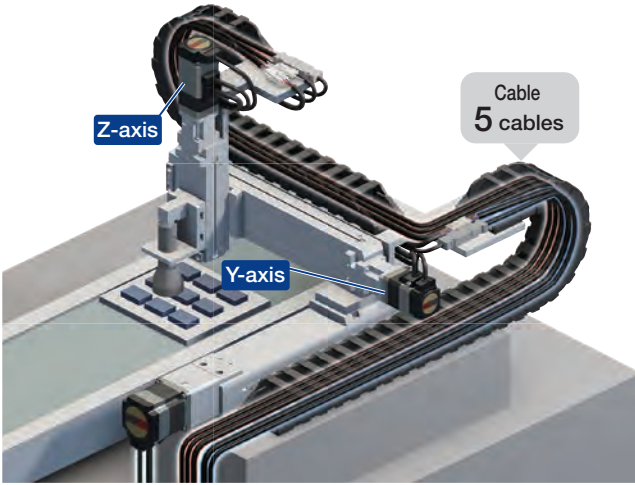

## Connector Type

Z-axis (Electromagnetic brake motor): 1 cable  
Y-axis (Standard motor) : 1 cable

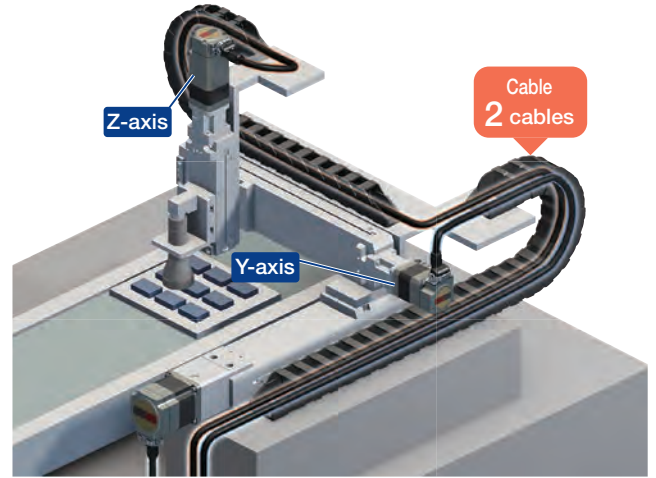

# Direct Connection Leads to Quicker Replacement of Motors and Cables

## Conventional Product (Cable type)

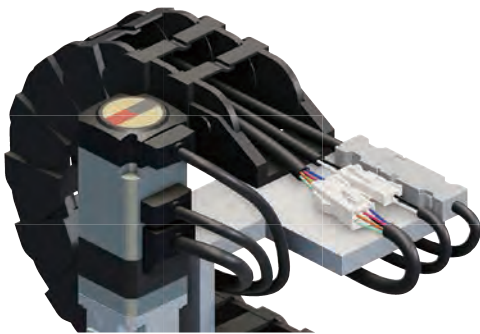

## Connector Type



## Reference: Comparison of Connection Cable Diameters, Cross-Section Areas and Masses

For electromagnetic brake motor, single-axis driver and flexible connection cable (5 m in length)

### Cable Type

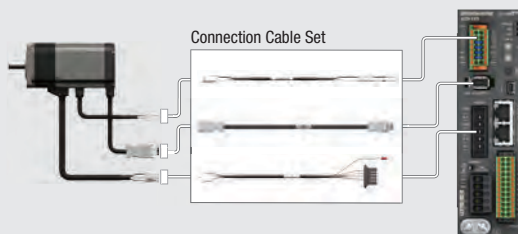

### Connector Type

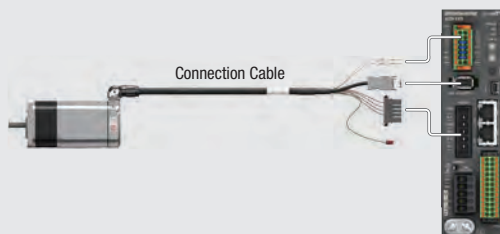



	Cable Type (3 cables)	Connector Type (1 cable)
Diameter [mm]	<ul style="list-style-type: none"> <li>• <math>\phi 8</math> for motors</li> <li>• <math>\phi 6</math> for electromagnetic brakes</li> <li>• <math>\phi 6.5</math> for encoders</li> </ul>	$\phi 8.9$
Cross-Sectional Area [mm <sup>2</sup> ]	111.7	62.2
	<b>44.3% reduction</b>	
Mass [kg]	1.19	0.53
	<b>55.5% reduction</b>	

\*3 cables: one for motor, one for encoder and one for electromagnetic brake

# Product Line of **AZ** Series

**AC** : Single-Phase 100-120 VAC,  
Single-Phase/Three-Phase 200-240 VAC Input  
**DC** : 24/48 VDC Input

## Motor (Frame Size: 42 mm, 60 mm)

Type	Electromagnetic Brake	Permissible Torque and Max. Instantaneous Torque [Nm]	Backlash [arcmin]	Basic Resolution [°/pulse]	Output Shaft Speed [r/min]
<b>Standard</b> <b>AC</b> <b>DC</b>  Motor Shaft Type Round with a Flat/Straight/Keyed	Not equipped	Max. Holding Torque 2	—	0.36	4500
	Equipped				
<b>TS Geared</b> <b>AC</b> <b>DC</b> <b>NEW</b> (Spur gear mechanism) Select the Connector Direction Down/Up/Right/Left Low Gear Ratio, High Speed Operation Gear Ratio: 3.6, 7.2, 10, 20, 30	Not equipped	Permissible Torque / Maximum Instantaneous Torque 6 / 10	10	0.012	833
	Equipped				
<b>Right-Angle FC Geared</b> <b>AC</b> <b>DC</b> <b>NEW</b> (Face gear mechanism) Select the Connector Direction Down/Up Right-Angle Gear for Positioning Gear Ratio: 7.2, 10, 20, 30	Not equipped	Permissible Torque 10.5	10	0.012	416
	Equipped				
<b>PS Geared</b> <b>AC</b> <b>DC</b> <b>NEW</b> (Planetary gear mechanism) Gear Ratios for Selecting the Desired Step Angle Gear Ratio: 5, 7.2, 10, 25, 36, 50	Not equipped	Permissible Torque / Maximum Instantaneous Torque 8 / 20	7	0.0072	600
	Equipped				
<b>Harmonic Geared Type (Harmonic drive)</b> <b>AC</b> <b>DC</b> <b>NEW</b>  High Positioning Accuracy Gear Ratio: 50, 100	Not equipped	Permissible Torque / Maximum Instantaneous Torque 10 / 36	0	0.0036	70
	Equipped				

**Note** Please use the above values as reference to see the differences between each type. These values vary depending on the motor frame size and gear ratio.

G geared motors, which have been pre-assembled with gears, are offered as variants of the **AZ** Series. Based on torque, accuracy (backlash) and price, the optimal type can be selected from the various geared motors.

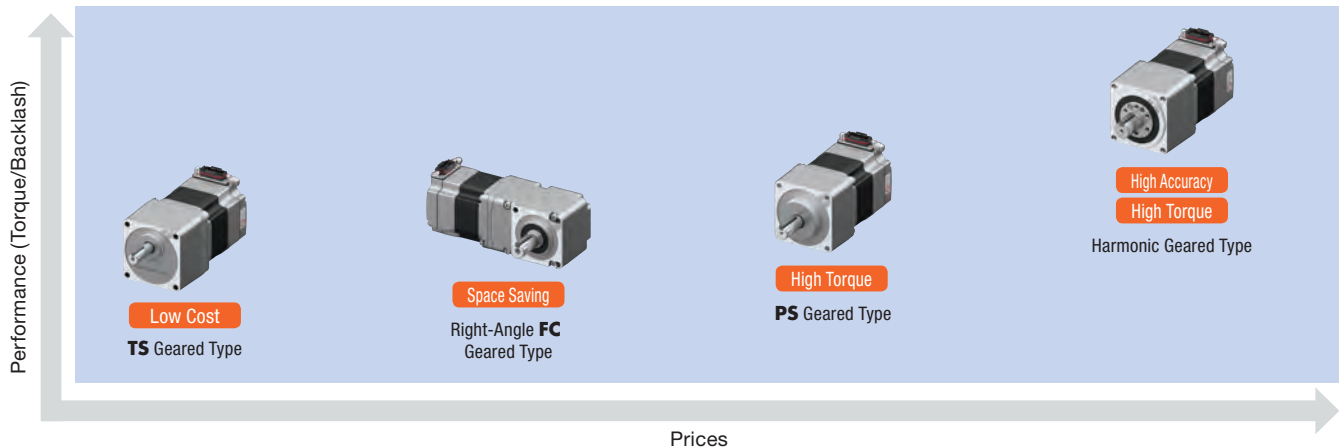

● Harmonic Drive and  are registered trademarks of Harmonic Drive Systems Inc.

## Single-Axis Drivers

### Network Compatible Driver

The driver can be controlled directly from the host control device via the FA network.

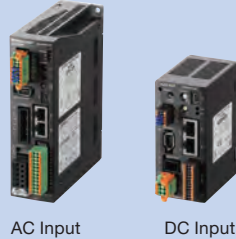

AC Input DC Input

### Built-In Positioning Function Type **FLEX**

Set the positioning data in the driver (256 points). Capable of FA network control when a network converter (sold separately) is used.

### Modbus (RTU)

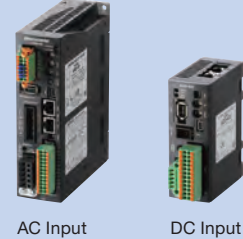

AC Input DC Input

### Pulse Input Type with RS-485 Communication

Control the motor from a positioning module (pulse generator). Monitor the motor's position, speed, torque, alarms and temperature via RS-485 communication.

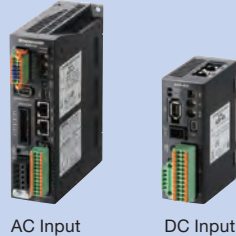

AC Input DC Input

### Pulse Input Type

The motor is controlled from the positioning module (pulse generator).

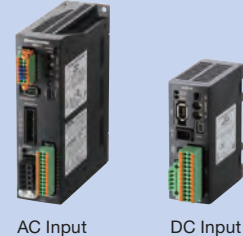

AC Input DC Input

## mini Drivers

More compact and lightweight than single-axis drivers. They are also compatible with FA network.



## Connection Cables/Flexible Connection Cables

Use a flexible connection cable in applications where the cable is bent and flexed.



- **EtherCAT** is a patented technology licensed from Beckhoff Automation GmbH (Germany) and is a registered trademark of that company.
- **EtherNet/IP** is a registered trademark of ODVA, **MECHATROLINK** is a registered trademark of MECHATROLINK Members Association, [CC-Link] is a registered trademark of CC-Link Partner Association, and **Modbus (RTU)** is a registered trademark of Schneider Automation Inc.
- **PROFINET** is a registered trademark or trademark of PROFIBUS Nutzerorganisation e.V.(PNO) and **SSCNET III/H** is a registered trademark or trademark of Mitsubishi Electric Corporation.

### **FLEX** What is FLEX?

FLEX is the collective name for products that support I/O control, Modbus (RTU) control and FA network control via network converters.

## System Configuration

### Combination of Connector Type Electromagnetic Brake Motor and Network-Compatible Driver

An example of a configuration using I/O control with EtherCAT-compatible driver or EtherCAT is shown below.

Motors, drivers, and connection cables/flexible connection cables must be ordered individually.

- Required for Operation
- Optional Accessory

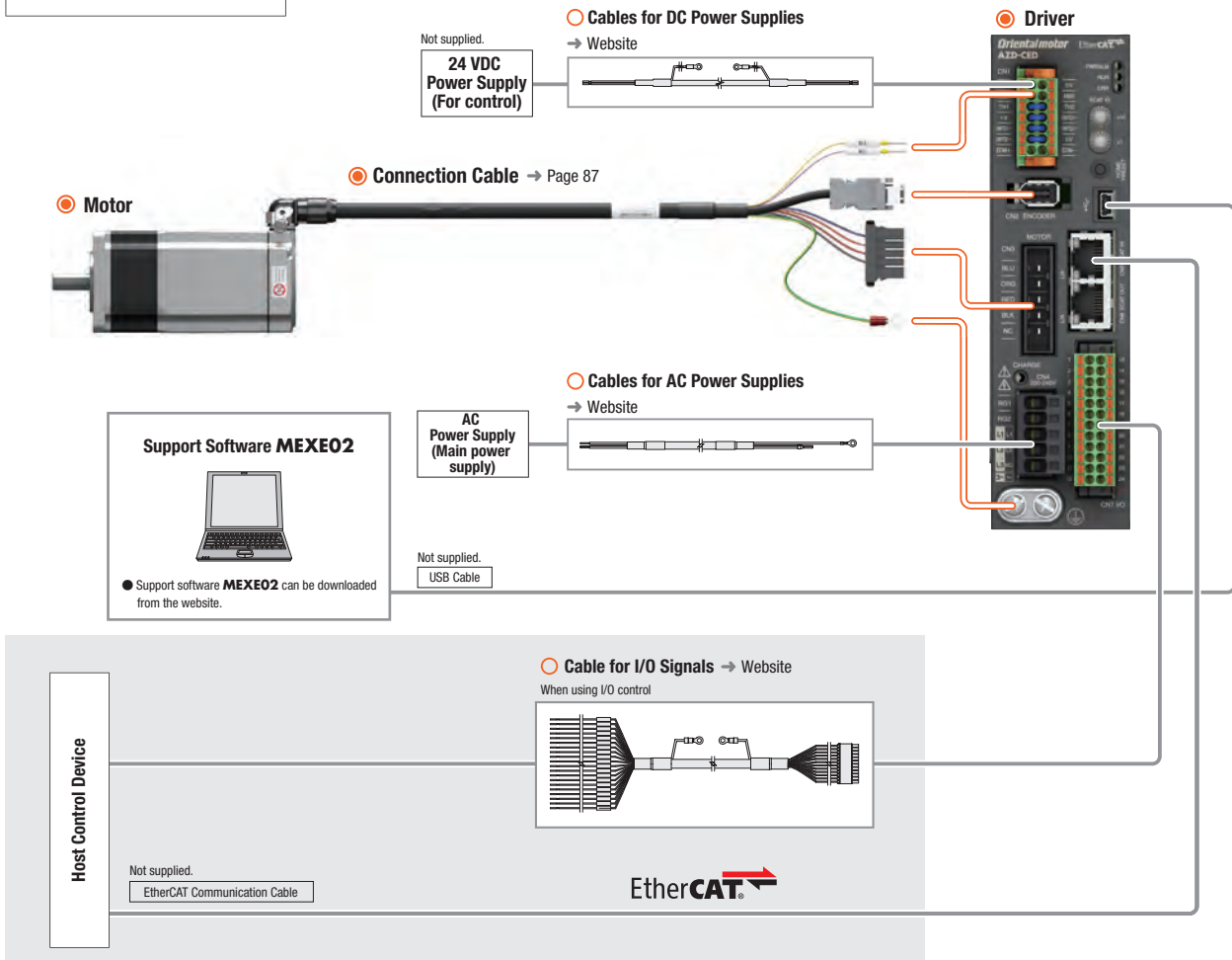

### Example of System Configuration

Motor	+	Driver	+	Cable	
<b>AZM66MCH</b>		<b>AZD-CED</b>		Connection Cable Cable Outlet Direction Output Shaft Side (1 m)	I/O Signal Cable Connector Type (1 m)
○		○		<b>CCM010Z1BFF</b>	<b>CC24D010C-1</b>

● The system configuration shown above is an example. Other combinations are also available.

## Product Number

### Motor

#### Standard Type

**AZM 6 6 A 0 C H**

① ② ③ ④ ⑤ ⑥ ⑦

#### PS, Harmonic Geared Type

**AZM 6 6 A C H-PS 7.2**

① ② ③ ④ ⑥ ⑦ ⑧ ⑨

#### TS Geared Type

**AZM 6 6 A C H-TS 7.2 U**

① ② ③ ④ ⑤ ⑥ ⑦ ⑧ ⑨

#### FC Geared Type

**AZM 6 6 A C H-FC 7.2 U A**

① ② ③ ④ ⑤ ⑥ ⑦ ⑧ ⑨ ⑩

### Connection Cables/Flexible Connection Cables

**CCM 010 Z1 A F F**

① ② ③ ④ ⑤ ⑥

①	Motor Type	<b>AZM: AZ</b> Series Motor
②	Motor Frame Size	<b>4:</b> 42 mm <b>6:</b> 60 mm
③	Motor Case Length	
④	Output Shaft Type	<b>A:</b> Single Shaft <b>M:</b> Type with Electromagnetic Brake
⑤	Additional Function*	<b>0:</b> Round Shaft <b>1:</b> Key Type
⑥	Motor Type	<b>C:</b> AC Input Specification
⑦	Motor Connection Method	<b>H:</b> Connector Type
⑧	Geared Type	<b>PS: PS</b> Geared Type <b>HS:</b> Harmonic Geared Type
⑨	Gear Ratio	

\*Standard type products without an additional function number have a round shaft with a flat section.

①	Motor Type	<b>AZM: AZ</b> Series Motor
②	Motor Frame Size	<b>4:</b> 42 mm <b>6:</b> 60 mm
③	Motor Case Length	
④	Output Shaft Type	<b>A:</b> Single Shaft <b>M:</b> Type with Electromagnetic Brake
⑤	Motor Type	<b>C:</b> AC Input Specification
⑥	Motor Connection Method	<b>H:</b> Connector Type
⑦	Geared Type	<b>TS: TS</b> Geared Type
⑧	Gear Ratio	
⑨	Connector Direction	<b>U:</b> Up <b>L:</b> Left <b>R:</b> Right

①	Motor Type	<b>AZM: AZ</b> Series Motor
②	Motor Frame Size	<b>4:</b> 42 mm <b>6:</b> 60 mm
③	Motor Case Length	
④	Output Shaft Type	<b>A:</b> Single Shaft <b>M:</b> Type with Electromagnetic Brake
⑤	Motor Type	<b>C:</b> AC Input Specification
⑥	Motor Connection Method	<b>H:</b> Connector Type
⑦	Geared Type	<b>FC: FC</b> Geared Type
⑧	Gear Ratio	
⑨	Connector Direction*	<b>D:</b> Down <b>U:</b> Up
⑩	Identification	<b>A:</b> Solid Shaft

\*The connector direction is as viewed from the gearhead side with the output shaft facing left.

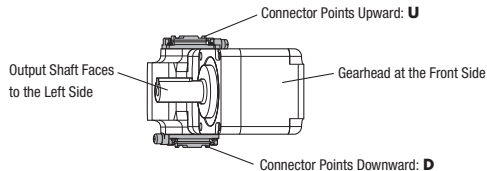

①		<b>CCM:</b> Cable
②	Length	<b>010:</b> 1 m, <b>020:</b> 2 m, <b>030:</b> 3 m, <b>050:</b> 5 m, <b>070:</b> 7 m, <b>100:</b> 10 m
③	Applicable Model	<b>Z1:</b> AZ Series Connector Type
④	Description	<b>A:</b> AC Input for Motor/Encoder <b>B:</b> AC Input For Motor/Encoder/ Electromagnetic Brake Type
⑤	Cable Outlet Direction*	<b>F:</b> Output Shaft Direction <b>V:</b> Vertical <b>B:</b> Opposite to Output Shaft Direction
⑥	Cable Type	<b>F:</b> Connection Cable <b>R:</b> Flexible Connection Cable

\*Three types of the connection cables with different cable outlet directions are available. Please select the cable outlet direction needed for the installation.



## Product Line

Motors, drivers, and connection cables must be ordered individually.

### ● Motor

#### ◇ Standard Type



Frame Size	Product Name
42 mm	<b>AZM46ACH</b> <b>AZM46A0CH</b> <b>AZM48ACH</b> <b>AZM48A0CH</b> <b>AZM48A1CH</b>
60 mm	<b>AZM66ACH</b> <b>AZM66A0CH</b> <b>AZM66A1CH</b> <b>AZM69ACH</b> <b>AZM69A0CH</b> <b>AZM69A1CH</b>

### ◇ Standard Type

#### with an Electromagnetic Brake



Frame Size	Product Name
42 mm	<b>AZM46MCH</b> <b>AZM46M0CH</b>
60 mm	<b>AZM66MCH</b> <b>AZM66M0CH</b> <b>AZM66M1CH</b> <b>AZM69MCH</b> <b>AZM69M0CH</b> <b>AZM69M1CH</b>

### ◇ TS Geared Type



Frame Size	Product Name
42 mm	<b>AZM46ACH-TS3.6</b> <b>AZM46ACH-TS3.6R</b> <b>AZM46ACH-TS3.6U</b> <b>AZM46ACH-TS3.6L</b> <b>AZM46ACH-TS7.2</b> <b>AZM46ACH-TS7.2R</b> <b>AZM46ACH-TS7.2U</b> <b>AZM46ACH-TS7.2L</b> <b>AZM46ACH-TS10</b> <b>AZM46ACH-TS10R</b> <b>AZM46ACH-TS10U</b> <b>AZM46ACH-TS10L</b> <b>AZM46ACH-TS20</b> <b>AZM46ACH-TS20R</b> <b>AZM46ACH-TS20U</b> <b>AZM46ACH-TS20L</b> <b>AZM46ACH-TS30</b> <b>AZM46ACH-TS30R</b> <b>AZM46ACH-TS30U</b> <b>AZM46ACH-TS30L</b>
60 mm	<b>AZM66ACH-TS3.6</b> <b>AZM66ACH-TS3.6R</b> <b>AZM66ACH-TS3.6U</b> <b>AZM66ACH-TS3.6L</b> <b>AZM66ACH-TS7.2</b> <b>AZM66ACH-TS7.2R</b> <b>AZM66ACH-TS7.2U</b> <b>AZM66ACH-TS7.2L</b> <b>AZM66ACH-TS10</b> <b>AZM66ACH-TS10R</b> <b>AZM66ACH-TS10U</b> <b>AZM66ACH-TS10L</b> <b>AZM66ACH-TS20</b> <b>AZM66ACH-TS20R</b> <b>AZM66ACH-TS20U</b> <b>AZM66ACH-TS20L</b> <b>AZM66ACH-TS30</b> <b>AZM66ACH-TS30R</b> <b>AZM66ACH-TS30U</b> <b>AZM66ACH-TS30L</b>

### ◇ TS Geared Type

#### with Electromagnetic Brake



Frame Size	Product Name
42 mm	<b>AZM46MCH-TS3.6</b> <b>AZM46MCH-TS3.6R</b> <b>AZM46MCH-TS3.6U</b> <b>AZM46MCH-TS3.6L</b> <b>AZM46MCH-TS7.2</b> <b>AZM46MCH-TS7.2R</b> <b>AZM46MCH-TS7.2U</b> <b>AZM46MCH-TS7.2L</b> <b>AZM46MCH-TS10</b> <b>AZM46MCH-TS10R</b> <b>AZM46MCH-TS10U</b> <b>AZM46MCH-TS10L</b> <b>AZM46MCH-TS20</b> <b>AZM46MCH-TS20R</b> <b>AZM46MCH-TS20U</b> <b>AZM46MCH-TS20L</b> <b>AZM46MCH-TS30</b> <b>AZM46MCH-TS30R</b> <b>AZM46MCH-TS30U</b> <b>AZM46MCH-TS30L</b>
60 mm	<b>AZM66MCH-TS3.6</b> <b>AZM66MCH-TS3.6R</b> <b>AZM66MCH-TS3.6U</b> <b>AZM66MCH-TS3.6L</b> <b>AZM66MCH-TS7.2</b> <b>AZM66MCH-TS7.2R</b> <b>AZM66MCH-TS7.2U</b> <b>AZM66MCH-TS7.2L</b> <b>AZM66MCH-TS10</b> <b>AZM66MCH-TS10R</b> <b>AZM66MCH-TS10U</b> <b>AZM66MCH-TS10L</b> <b>AZM66MCH-TS20</b> <b>AZM66MCH-TS20R</b> <b>AZM66MCH-TS20U</b> <b>AZM66MCH-TS20L</b> <b>AZM66MCH-TS30</b> <b>AZM66MCH-TS30R</b> <b>AZM66MCH-TS30U</b> <b>AZM66MCH-TS30L</b>

System Configuration	Product Line	Specifications and Characteristics	Dimensions
AC Input	DC Input	System Configuration	Product Line
		Specifications and Characteristics	Dimensions
		Cable	



◇FC Geared Type

Frame Size	Product Name
42 mm	<b>AZM46ACH-FC7.2UA</b> <b>AZM46ACH-FC7.2DA</b> <b>AZM46ACH-FC10UA</b> <b>AZM46ACH-FC10DA</b> <b>AZM46ACH-FC20UA</b> <b>AZM46ACH-FC20DA</b> <b>AZM46ACH-FC30UA</b> <b>AZM46ACH-FC30DA</b>
60 mm	<b>AZM66ACH-FC7.2UA</b> <b>AZM66ACH-FC7.2DA</b> <b>AZM66ACH-FC10UA</b> <b>AZM66ACH-FC10DA</b> <b>AZM66ACH-FC20UA</b> <b>AZM66ACH-FC20DA</b> <b>AZM66ACH-FC30UA</b> <b>AZM66ACH-FC30DA</b>

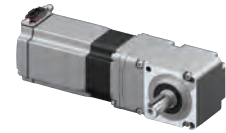

◇FC Geared Type  
with Electromagnetic Brake

Frame Size	Product Name
42 mm	<b>AZM46MCH-FC7.2UA</b> <b>AZM46MCH-FC7.2DA</b> <b>AZM46MCH-FC10UA</b> <b>AZM46MCH-FC10DA</b> <b>AZM46MCH-FC20UA</b> <b>AZM46MCH-FC20DA</b> <b>AZM46MCH-FC30UA</b> <b>AZM46MCH-FC30DA</b>
60 mm	<b>AZM66MCH-FC7.2UA</b> <b>AZM66MCH-FC7.2DA</b> <b>AZM66MCH-FC10UA</b> <b>AZM66MCH-FC10DA</b> <b>AZM66MCH-FC20UA</b> <b>AZM66MCH-FC20DA</b> <b>AZM66MCH-FC30UA</b> <b>AZM66MCH-FC30DA</b>



◇PS Geared Type

Frame Size	Product Name
42 mm	<b>AZM46ACH-PS5</b> <b>AZM46ACH-PS7.2</b> <b>AZM46ACH-PS10</b> <b>AZM46ACH-PS25</b> <b>AZM46ACH-PS36</b> <b>AZM46ACH-PS50</b>
60 mm	<b>AZM66ACH-PS5</b> <b>AZM66ACH-PS7.2</b> <b>AZM66ACH-PS10</b> <b>AZM66ACH-PS25</b> <b>AZM66ACH-PS36</b> <b>AZM66ACH-PS50</b>



◇PS Geared Type  
with Electromagnetic Brake

Frame Size	Product Name
42 mm	<b>AZM46MCH-PS5</b> <b>AZM46MCH-PS7.2</b> <b>AZM46MCH-PS10</b> <b>AZM46MCH-PS25</b> <b>AZM46MCH-PS36</b> <b>AZM46MCH-PS50</b>
60 mm	<b>AZM66MCH-PS5</b> <b>AZM66MCH-PS7.2</b> <b>AZM66MCH-PS10</b> <b>AZM66MCH-PS25</b> <b>AZM66MCH-PS36</b> <b>AZM66MCH-PS50</b>



◇Harmonic Geared Type

Frame Size	Product Name
42 mm	<b>AZM46ACH-HS50</b> <b>AZM46ACH-HS100</b>
60 mm	<b>AZM66ACH-HS50</b> <b>AZM66ACH-HS100</b>



◇Harmonic Geared Type  
with Electromagnetic Brake

Frame Size	Product Name
42 mm	<b>AZM46MCH-HS50</b> <b>AZM46MCH-HS100</b>
60 mm	<b>AZM66MCH-HS50</b> <b>AZM66MCH-HS100</b>

●Connection Cables/Flexible Connection Cables

A connection cable is needed to connect the motor and driver. Please be sure to purchase one.

Use a flexible connection cable in applications where the cable is bent and flexed. Refer to page 87 for details.

■Included Items

Type	Included Items	Parallel Key	Motor Installation Screws
Standard Type	Round Shaft with Flat	-	-
	Straight Type	-	-
	With Key	1 piece	-
TS Geared Type	Frame Size 42 mm	-	-
	Frame Size 60 mm	1 piece	M4×60 P0.7 (4 screws)
FC Geared Type		1 piece	-
PS Geared Type		1 piece	-
Harmonic Geared Type		1 piece	-



## List of Combinations

Product	Type	Product Name
Motor	Standard Type	<b>AZM46</b> <input type="checkbox"/> <b>CH</b> , <b>AZM48A</b> <input type="checkbox"/> <b>CH</b> <b>AZM66</b> <input type="checkbox"/> <b>CH</b> , <b>AZM69</b> <input type="checkbox"/> <b>CH</b>
	<b>TS</b> Geared Type	<b>AZM46</b> <input type="checkbox"/> <b>CH-TS</b> <input type="checkbox"/> <input type="checkbox"/> <b>AZM66</b> <input type="checkbox"/> <b>CH-TS</b> <input type="checkbox"/> <input type="checkbox"/>
	<b>FC</b> Geared Type	<b>AZM46</b> <input type="checkbox"/> <b>CH-FC</b> <input type="checkbox"/> <input type="checkbox"/> <b>A</b> <b>AZM66</b> <input type="checkbox"/> <b>CH-FC</b> <input type="checkbox"/> <input type="checkbox"/> <b>A</b>
	<b>PS</b> Geared Type	<b>AZM46</b> <input type="checkbox"/> <b>CH-PS</b> <input type="checkbox"/> <b>AZM66</b> <input type="checkbox"/> <b>CH-PS</b> <input type="checkbox"/>
	Harmonic Geared Type	<b>AZM46</b> <input type="checkbox"/> <b>CH-HS</b> <input type="checkbox"/> <b>AZM66</b> <input type="checkbox"/> <b>CH-HS</b> <input type="checkbox"/>

+

Product Line	Type	Product Name
Driver	EtherCAT Drive Profile-Compatible	<b>AZD-AED</b> , <b>AZD-CED</b>
	EtherNet/IP-Compatible	<b>AZD-AEP</b> , <b>AZD-CEP</b>
	PROFINET-Compatible	<b>AZD-APN</b> , <b>AZD-CPN</b>
	MECHATROLINK-III-Compatible	<b>AZD-AM3</b> , <b>AZD-CM3</b>
	SSCNETIII/H-Compatible	<b>AZD-AS3</b> , <b>AZD-CS3</b>
	Built-in Controller Type	<b>AZD-AD</b> , <b>AZD-CD</b>
	Pulse Input Type with RS-485 Communication	<b>AZD-AX</b> , <b>AZD-CX</b>
Pulse Input Type	<b>AZD-A</b> , <b>AZD-C</b>	

+

Product Line	Type	Product Name
Connection Cables/Flexible Connection Cables	Connection Cable	For motor/encoder: <b>CCM</b> <input type="checkbox"/> <input type="checkbox"/> <input type="checkbox"/> <input type="checkbox"/> <b>Z1A</b> <input type="checkbox"/> <b>F</b> For motor/encoder/electromagnetic brake: <b>CCM</b> <input type="checkbox"/> <input type="checkbox"/> <input type="checkbox"/> <input type="checkbox"/> <b>Z1B</b> <input type="checkbox"/> <b>F</b>
	Flexible Connection Cable	For motor/encoder: <b>CCM</b> <input type="checkbox"/> <input type="checkbox"/> <input type="checkbox"/> <input type="checkbox"/> <b>Z1A</b> <input type="checkbox"/> <b>R</b> For motor/encoder/electromagnetic brake: <b>CCM</b> <input type="checkbox"/> <input type="checkbox"/> <input type="checkbox"/> <input type="checkbox"/> <b>Z1B</b> <input type="checkbox"/> <b>R</b>

● A code or a number indicating either one of the following product lines is entered where the box is located within the product name.

- : Output Shaft Configuration
- : Additional Function
- : Gear Ratio
- : Connector Direction
- : Cable Outlet Direction
- : Cable Length

System Configuration

Product Line

AC Input

Specifications and Characteristics

Dimensions

System Configuration

Product Line

DC Input

Specifications and Characteristics

Dimensions

Cable

### ● AZ Series Catalog (V-184)

- Driver Functions
- Communication Specifications
- Driver Dimensions
- Cables & Peripheral Equipment



● Please see the Oriental Motor website or the AZ Series catalog for details about the drivers that can be combined.

# Standard Type Frame Size 42 mm, 60 mm

## Specifications



Motor Product Name	Single Shaft	AZM46A□CH	AZM48A□CH	AZM66A□CH	AZM69A□CH
Driver Product Name	With Electromagnetic Brake	AZM46M□CH	—	AZM66M□CH	AZM69M□CH
Max. Holding Torque	Nm	0.3	0.77	1.2	2
Holding Torque at Motor Standstill	Power ON	Nm	0.38	0.6	1
	Electromagnetic Brake	Nm	—	0.6	1
Rotor Inertia	J: kgm <sup>2</sup>	$55 \times 10^{-7}$ [ $71 \times 10^{-7}$ ]*	$115 \times 10^{-7}$	$370 \times 10^{-7}$ [ $530 \times 10^{-7}$ ]*	$740 \times 10^{-7}$ [ $900 \times 10^{-7}$ ]*
Resolution	Resolution Setting: 1000 P/R	0.36°/Pulse			
Power Supply Input	Please check "Driver Specifications" on page 18 for the driver current specifications when combined with a motor.				
Control Power Supply					

● Either a **0** (straight type) or **1** (key type) indicating the additional function is specified where the box □ is located in the product name. (**AZM46** is straight type only) For single shaft flat type motors, there is no number in the □ box.

A letter indicating the driver type is specified where the box ■ is located in the product name. Please check "List of Combinations" on page 9 for driver product names.

\*The value inside the ( ) represents the value when an electromagnetic brake motor is connected.

## Speed – Torque Characteristics (Reference values)

**AZM46**

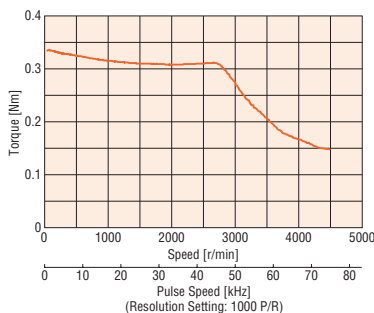

**AZM48**

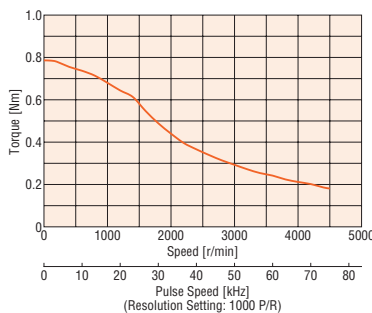

**AZM66**

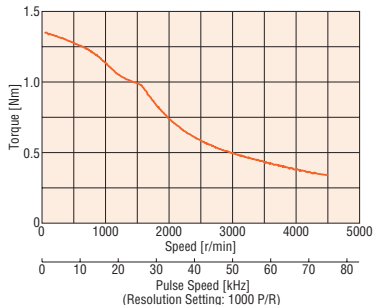

**AZM69**

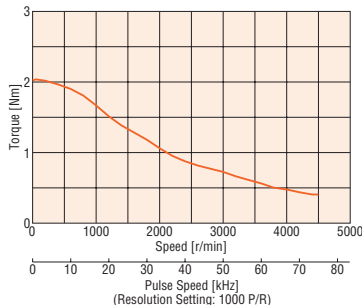

### Note

- Data for the speed – torque characteristics is based on Oriental Motor's internal measurement conditions. If the conditions are changed, the characteristics may also change as a result.
- Depending on the driving conditions, a considerable amount of heat may be generated by the motor. To protect the Absolute Sensor, be sure to keep the temperature of the motor case at 80°C or less. (When conforming to the UL or CSA Standards, the temperature of the motor case must be kept at 75°C or less since the motor is recognized as heat-resistant class A.)

## Explanation of Terminology in Specifications Table

Maximum Holding Torque	:This is the max. holding torque (holding force) the motor has when power is supplied (at rated current) but the motor is not rotating. (With geared types, the value of holding torque considers the permissible strength of the gear.)
Permissible Torque	:This is the maximum value of the torque continuously applied to the output gear shaft.
Maximum Instantaneous Torque	:This is the max. torque that can be applied to the output gear shaft during acceleration/deceleration such when an inertial load is started and stopped.
Holding Torque at Motor Standstill	While Power is ON :Holding torque when the automatic current cutback function is active is shown. Electromagnetic Brake :Static friction torque when the electromagnetic brake is activated at standstill is shown. (Electromagnetic brake is power off activated type.)

# TS Geared Type Frame Size 42 mm

## Specifications



Motor Product Name	Single Shaft	AZM46ACH-TS3.6	AZM46ACH-TS7.2	AZM46ACH-TS10	AZM46ACH-TS20	AZM46ACH-TS30	
Motor Product Name	With Electromagnetic Brake	AZM46MCH-TS3.6	AZM46MCH-TS7.2	AZM46MCH-TS10	AZM46MCH-TS20	AZM46MCH-TS30	
Driver Product Name	AZD-A, AZD-C						
Max. Holding Torque	Nm	0.65	1.2	1.7	2	2.3	
Rotor Inertia	J: kgm <sup>2</sup>	55×10 <sup>-7</sup> (71×10 <sup>-7</sup> )*1					
Gear Ratio		3.6	7.2	10	20	30	
Resolution	Resolution Setting: 1000 P/R *2	0.1°/Pulse	0.05°/Pulse	0.036°/Pulse	0.018°/Pulse	0.012°/Pulse	
Permissible Torque	Nm	0.65	1.2	1.7	2	2.3	
Max. Instantaneous Torque	Nm	0.85	1.6	2	3		
Holding Torque at Motor Standstill	Power ON	Nm	0.54	1	1.5	1.9	2.2
	Electromagnetic Brake	Nm	0.54	1	1.5	1.9	2.2
Permissible Speed Range	r/min	0~833	0~416	0~300	0~150	0~100	
Backlash	arcmin	45 (0.75°)	25 (0.42°)		15 (0.25°)		
Power Supply Input	Check "Driver Specifications" on page 18 for the driver current when combined with a motor.						
Control Power Supply							

● Either **R** (Right), **U** (Up), or **L** (Left) indicating the cable outlet direction is specified where the box  is located in the product name. For down, there is no character in the box .

A letter indicating the driver type is specified where the box  is located in the product name. Check "List of Combinations" on page 9 for driver product names.

\*1 The value inside the ( ) represents the value when connecting an electromagnetic brake motor.

\*2 For SSCNETIII/H compatible drivers, the resolution is fixed at 10,000 P/R.

## Speed – Torque Characteristics (Reference values)

**AZM46 Gear Ratio 3.6**

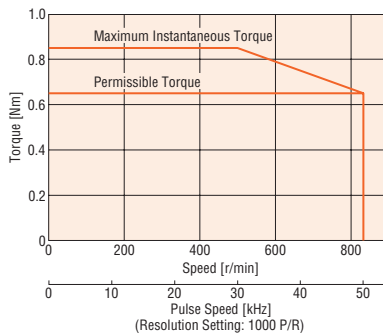

**AZM46 Gear Ratio 7.2**

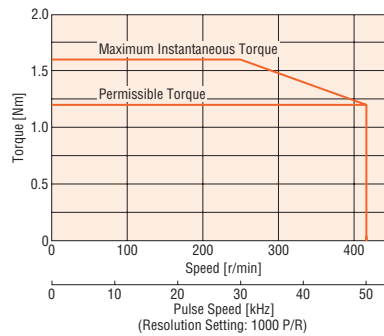

**AZM46 Gear Ratio 10**

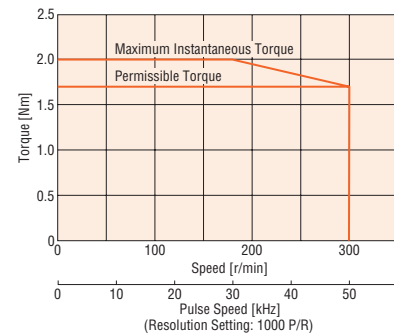

**AZM46 Gear Ratio 20**

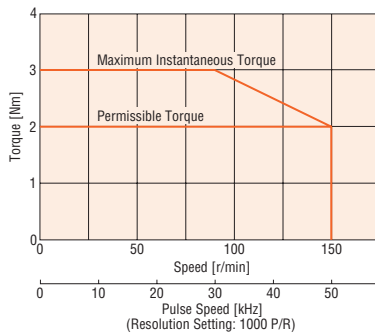

**AZM46 Gear Ratio 30**

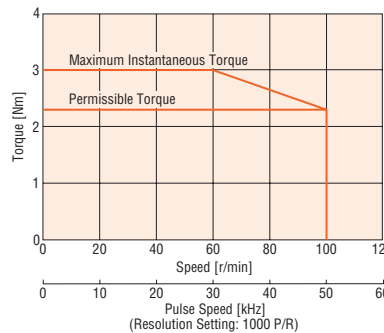

### Note

- Data for the speed – torque characteristics is based on Oriental Motor's internal measurement conditions. If the conditions are changed, the characteristics may also change as a result.
- Depending on the driving conditions, a considerable amount of heat may be generated by the motor. To protect the absolute sensor, be sure to keep the temperature of the motor case at 80°C or less. (When conforming to the UL or CSA Standards, the temperature of the motor case must be kept at 75°C or less since the motor is recognized as heat-resistant class A.)
- For SSCNETIII/H compatible drivers, the resolution is fixed at 10,000 P/R.

System Configuration  
Product Line  
AC Input  
Specifications and Characteristics  
Dimensions  
System Configuration  
Product Line  
DC Input  
Specifications and Characteristics  
Dimensions  
Cable

# TS Geared Type Frame Size 60 mm

## Specifications



Motor Product Name	Single Shaft	AZM66ACH-TS3.6	AZM66ACH-TS7.2	AZM66ACH-TS10	AZM66ACH-TS20	AZM66ACH-TS30
Motor Product Name	With Electromagnetic Brake	AZM66MCH-TS3.6	AZM66MCH-TS7.2	AZM66MCH-TS10	AZM66MCH-TS20	AZM66MCH-TS30
Driver Product Name	AZD-A, AZD-C					
Max. Holding Torque	Nm	1.8	3	4	5	6
Rotor Inertia	J: kgm <sup>2</sup>	370×10 <sup>-7</sup> (530×10 <sup>-7</sup> )* <sup>1</sup>				
Gear Ratio		3.6	7.2	10	20	30
Resolution	Resolution Setting: 1000 P/R * <sup>2</sup>	0.1°/Pulse	0.05°/Pulse	0.036°/Pulse	0.018°/Pulse	0.012°/Pulse
Permissible Torque	Nm	1.8	3	4	5	6
Max. Instantaneous Torque*	Nm	*	4.5	6	8	10
Holding Torque at Power ON	Nm	1.3	2.6	3.7	5	6
Holding Torque at Motor Standstill	Electromagnetic Brake Nm	1.3	2.6	3.7	5	6
Permissible Speed Range	r/min	0~833	0~416	0~300	0~150	0~100
Backlash	arcmin	35 (0.59°)	15 (0.25°)		10 (0.17°)	
Power Supply Input	Check "Driver Specifications" on page 18 for the driver current when combined with a motor.					
Control Power Supply						

● Either **R** (Right), **U** (Up), or **L** (Left) indicating the cable outlet direction is specified where the box  is located in the product name. For down, there is no character in the box .

A letter indicating the driver type is specified where the box  is located in the product name. Check "List of Combinations" on page 9 for driver product names.

\* For the geared motor output torque, refer to the speed-torque characteristics.

\*<sup>1</sup> The value inside the ( ) represents the value when connecting an electromagnetic brake motor.

\*<sup>2</sup> For SSCNETIII/H compatible drivers, the resolution is fixed at 10,000 P/R.

## Speed – Torque Characteristics (Reference values)

**AZM66 Gear Ratio 3.6**

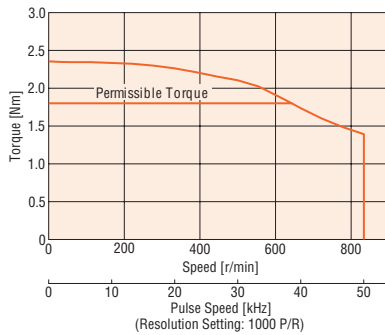

**AZM66 Gear Ratio 7.2**

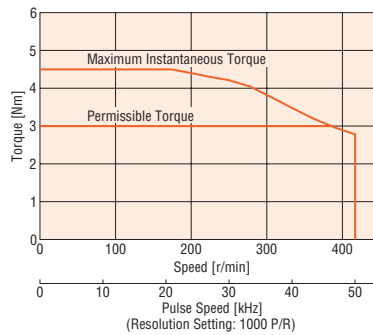

**AZM66 Gear Ratio 10**

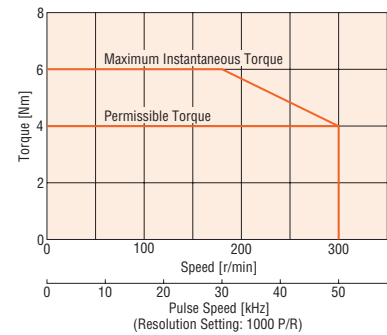

**AZM66 Gear Ratio 20**

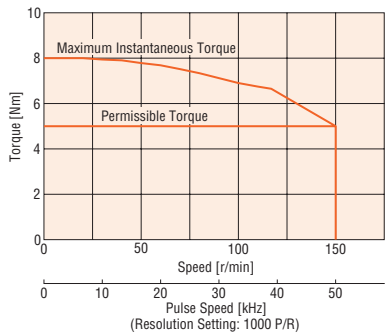

**AZM66 Gear Ratio 30**

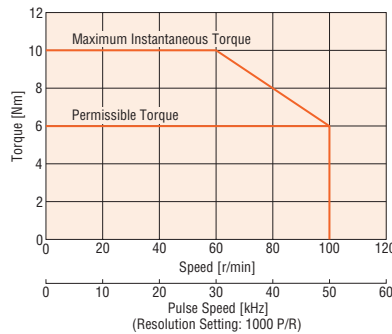

### Note

- Data for the speed – torque characteristics is based on Oriental Motor's internal measurement conditions. If the conditions are changed, the characteristics may also change as a result.
- Depending on the driving conditions, a considerable amount of heat may be generated by the motor. To protect the absolute sensor, be sure to keep the temperature of the motor case at 80°C or less. (When conforming to the UL or CSA Standards, the temperature of the motor case must be kept at 75°C or less since the motor is recognized as heat-resistant class A.)
- For SSCNETIII/H compatible drivers, the resolution is fixed at 10,000 P/R.

# FC Geared Type Frame Size 42 mm

## Specifications



Motor Product Name	Single Shaft	AZM46ACH-FC7.2□A	AZM46ACH-FC10□A	AZM46ACH-FC20□A	AZM46ACH-FC30□A
Driver Product Name	With Electromagnetic Brake	AZM46MCH-FC7.2□A	AZM46MCH-FC10□A	AZM46MCH-FC20□A	AZM46MCH-FC30□A
Max. Holding Torque	Nm	0.7	1	2	3
Rotor Inertia	J: kgm <sup>2</sup>	55×10 <sup>-7</sup> (71×10 <sup>-7</sup> )*1			
Gear Ratio		7.2	10	20	30
Resolution	Resolution Setting: 1000 P/R *2	0.05°/Pulse	0.036°/Pulse	0.018°/Pulse	0.012°/Pulse
Permissible Torque	Nm	0.7	1	2	3
Holding Torque at	Power ON	0.7	1	2	3
Motor Standstill	Electromagnetic Brake	0.7	1	2	3
Permissible Speed Range	r/min	0~416	0~300	0~150	0~100
Backlash	arcmin	25 (0.42°)		15 (0.25°)	
Power Supply Input		Check "Driver Specifications" on page 18 for the driver current when combined with a motor.			
Control Power Supply					

- Either **U** (Up) or **D** (Down) indicating the cable outlet direction is specified where the box □ is located in the product name.
- A letter indicating the driver type is specified where the box ■ is located in the product name. Check "List of Combinations" on page 9 for driver product names.
- \*1 The value inside the ( ) represents the value when connecting an electromagnetic brake motor.
- \*2 For SSCNETIII/H compatible drivers, the resolution is fixed at 10,000 P/R.

## Speed – Torque Characteristics (Reference values)

**AZM46 Gear Ratio 7.2**

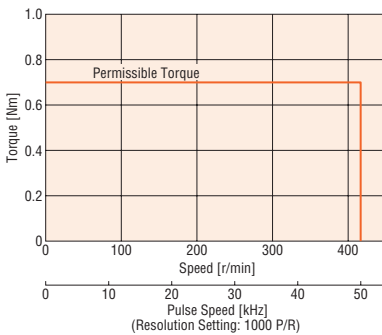

**AZM46 Gear Ratio 10**

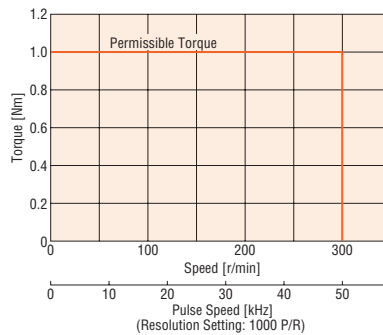

**AZM46 Gear Ratio 20**

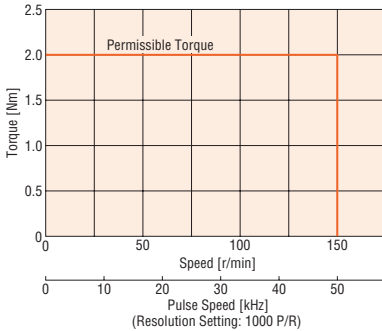

**AZM46 Gear Ratio 30**

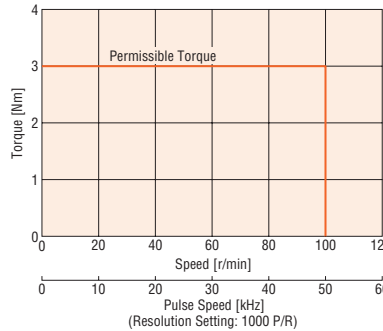

### Note

- Data for the speed – torque characteristics is based on Oriental Motor's internal measurement conditions. If the conditions are changed, the characteristics may also change as a result.
- Depending on the driving conditions, a considerable amount of heat may be generated by the motor. To protect the absolute sensor, be sure to keep the temperature of the motor case at 80°C or less. (When conforming to the UL or CSA Standards, the temperature of the motor case must be kept at 75°C or less since the motor is recognized as heat-resistant class A.)
- For SSCNETIII/H compatible drivers, the resolution is fixed at 10,000 P/R.

System Configuration

Product Line

AC Input

Specifications and Characteristics

Dimensions

System Configuration

Product Line

DC Input

Specifications and Characteristics

Dimensions

Cable

# FC Geared Type Frame Size 60 mm

## Specifications



Motor Product Name	Single Shaft	AZM66ACH-FC7.2□A	AZM66ACH-FC10□A	AZM66ACH-FC20□A	AZM66ACH-FC30□A
Motor Product Name	With Electromagnetic Brake	AZM66MCH-FC7.2□A	AZM66MCH-FC10□A	AZM66MCH-FC20□A	AZM66MCH-FC30□A
Driver Product Name		AZD-A□, AZD-C□			
Max. Holding Torque	Nm	2.5	3.5	7	10.5
Rotor Inertia	J: kgm <sup>2</sup>	370×10 <sup>-7</sup> (530×10 <sup>-7</sup> )*1			
Gear Ratio		7.2	10	20	30
Resolution	Resolution Setting: 1000 P/R *2	0.05°/Pulse	0.036°/Pulse	0.018°/Pulse	0.012°/Pulse
Permissible Torque	Nm	2.5	3.5	7	10.5
Holding Torque at	Power ON	2.5	3.5	7	10.5
Motor Standstill	Electromagnetic Brake	2.5	3.5	7	10.5
Permissible Speed Range	r/min	0~416	0~300	0~150	0~100
Backlash	arcmin	15 (0.25°)		10 (0.17°)	
Power Supply Input		Check "Driver Specifications" on page 18 for the driver current when combined with a motor.			
Control Power Supply					

- Either **U** (Up) or **D** (Down) indicating the cable outlet direction is specified where the box □ is located in the product name.
- A letter indicating the driver type is specified where the box ■ is located in the product name. Check "List of Combinations" on page 9 for driver product names.
- \*1 The value inside the ( ) represents the value when connecting an electromagnetic brake motor.
- \*2 For SSCNETIII/H compatible drivers, the resolution is fixed at 10,000 P/R.

## Speed – Torque Characteristics (Reference values)

**AZM66 Gear Ratio 7.2**

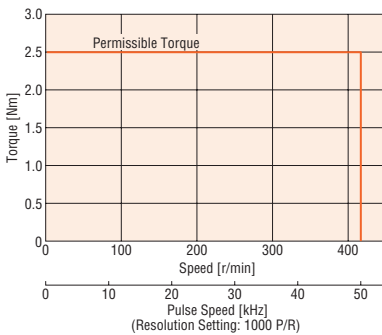

**AZM66 Gear Ratio 10**

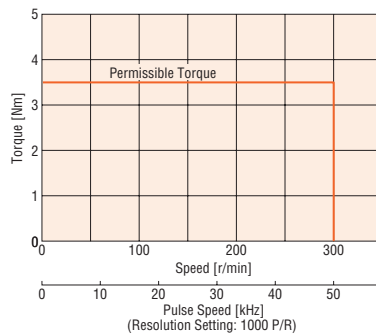

**AZM66 Gear Ratio 20**

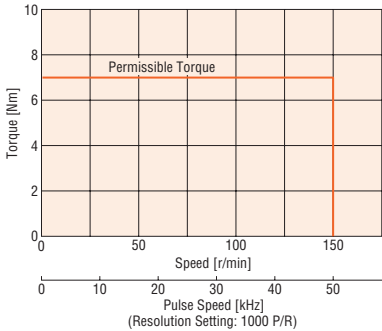

**AZM66 Gear Ratio 30**

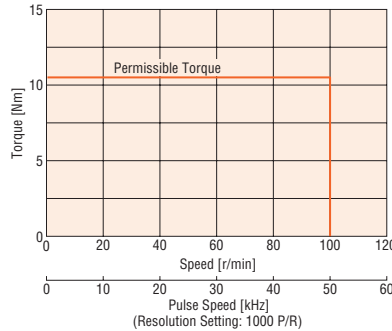

### Note

- Data for the speed – torque characteristics is based on Oriental Motor's internal measurement conditions. If the conditions are changed, the characteristics may also change as a result.
- Depending on the driving conditions, a considerable amount of heat may be generated by the motor. To protect the absolute sensor, be sure to keep the temperature of the motor case at 80°C or less. (When conforming to the UL or CSA Standards, the temperature of the motor case must be kept at 75°C or less since the motor is recognized as heat-resistant class A.)
- For SSCNETIII/H compatible drivers, the resolution is fixed at 10,000 P/R.

# PS Geared Type Frame Size 42 mm

## Specifications



Motor Product Name	Single Shaft	AZM46ACH-PS5	AZM46ACH-PS7.2	AZM46ACH-PS10	AZM46ACH-PS25	AZM46ACH-PS36	AZM46ACH-PS50
Motor Product Name	With Electromagnetic Brake	AZM46MCH-PS5	AZM46MCH-PS7.2	AZM46MCH-PS10	AZM46MCH-PS25	AZM46MCH-PS36	AZM46MCH-PS50
Driver Product Name		AZD-A□, AZD-C□					
Max. Holding Torque	Nm	1		1.5		2.5	3
Rotor Inertia	J: kgm <sup>2</sup>	55×10 <sup>-7</sup> (71×10 <sup>-7</sup> )*1					
Gear Ratio		5	7.2	10	25	36	50
Resolution	Resolution Setting: 1000 P/R *2	0.072°/Pulse	0.05°/Pulse	0.036°/Pulse	0.0144°/Pulse	0.01°/Pulse	0.0072°/Pulse
Permissible Torque	Nm	1	1.5		2.5	3	
Max. Instantaneous Torque	Nm	1.5	2		6		
Holding Torque at Power ON	Nm	0.75	1	1.5	2.5	3	
Motor Standstill Electromagnetic Brake	Nm	0.75	1	1.5	2.5	3	
Permissible Speed Range	r/min	0~600	0~416	0~300	0~120	0~83	0~60
Backlash	arcmin	15 (0.25°)					
Power Supply Input		Check "■ Driver Specifications" on page 18 for the driver current when combined with a motor.					
Control Power Supply							

● A letter indicating the driver type is specified where the box □ is located in the product name. Check "■ List of Combinations" on page 9 for driver product names.

\*1 The value inside the ( ) represents the value when connecting an electromagnetic brake motor.

\*2 For SSCNETIII/H compatible drivers, the resolution is fixed at 10,000 P/R.

## Speed – Torque Characteristics (Reference values)

**AZM46 Gear Ratio 5**

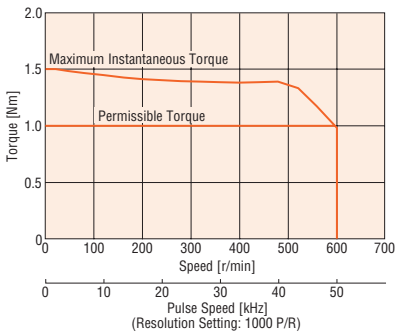

**AZM46 Gear Ratio 7.2**

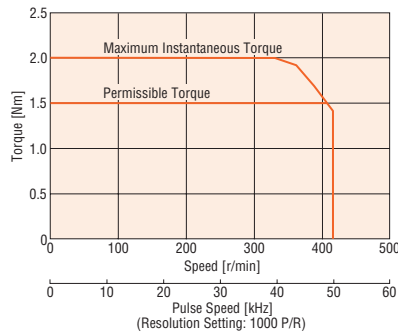

**AZM46 Gear Ratio 10**

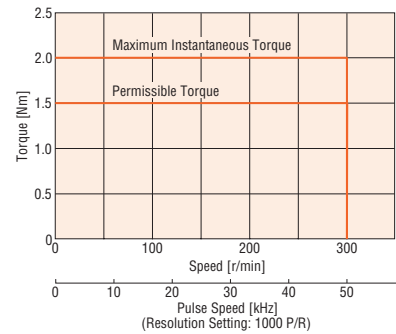

**AZM46 Gear Ratio 25**

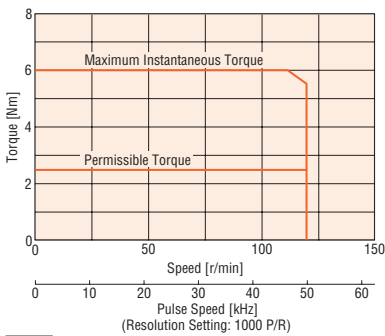

**AZM46 Gear Ratio 36**

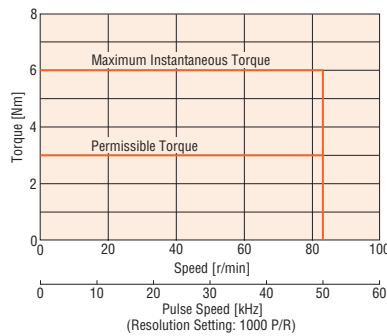

**AZM46 Gear Ratio 50**

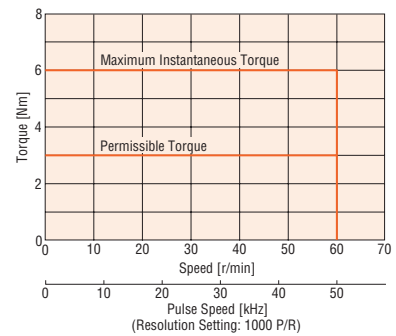

**Note**

- Data for the speed – torque characteristics is based on Oriental Motor's internal measurement conditions. If the conditions are changed, the characteristics may also change as a result.
- Depending on the driving conditions, a considerable amount of heat may be generated by the motor. To protect the absolute sensor, be sure to keep the temperature of the motor case at 80°C or less. (When conforming to the UL or CSA Standards, the temperature of the motor case must be kept at 75°C or less since the motor is recognized as heat-resistant class A.)
- For SSCNETIII/H compatible drivers, the resolution is fixed at 10,000 P/R.

System Configuration  
Product Line  
AC Input  
Specifications and Characteristics  
Dimensions  
System Configuration  
Product Line  
DC Input  
Specifications and Characteristics  
Dimensions  
Cable

# PS Geared Type Frame Size 60 mm

## Specifications



Motor Product Name	Single Shaft	AZM66ACH-PS5	AZM66ACH-PS7.2	AZM66ACH-PS10	AZM66ACH-PS25	AZM66ACH-PS36	AZM66ACH-PS50
Motor Product Name	With Electromagnetic Brake	AZM66MCH-PS5	AZM66MCH-PS7.2	AZM66MCH-PS10	AZM66MCH-PS25	AZM66MCH-PS36	AZM66MCH-PS50
Driver Product Name		AZD-A□, AZD-C□					
Max. Holding Torque	Nm	3.5	4	5	8		
Rotor Inertia	J: kgm <sup>2</sup>	370×10 <sup>-7</sup> (530×10 <sup>-7</sup> )*1					
Gear Ratio		5	7.2	10	25	36	50
Resolution	Resolution Setting: 1000 P/R *2	0.072°/Pulse	0.05°/Pulse	0.036°/Pulse	0.0144°/Pulse	0.01°/Pulse	0.0072°/Pulse
Permissible Torque	Nm	3.5	4	5	8		
Max. Instantaneous Torque*	Nm	*	*	11	16	20	
Holding Torque at Power ON	Nm	3	4	5	8		
Motor Standstill Electromagnetic Brake	Nm	3	4	5	8		
Permissible Speed Range	r/min	0~600	0~416	0~300	0~120	0~83	0~60
Backlash	arcmin	7 (0.12°)			9 (0.15°)		
Power Supply Input		Check "Driver Specifications" on page 18 for the driver current when combined with a motor.					
Control Power Supply							

● A letter indicating the driver type is specified where the box □ is located in the product name. Check "List of Combinations" on page 9 for driver product names.

\* For the geared motor output torque, refer to the speed-torque characteristics.

\*1 The value inside the ( ) represents the value when connecting an electromagnetic brake motor.

\*2 For SSCNETIII/H compatible drivers, the resolution is fixed at 10,000 P/R.

## Speed – Torque Characteristics (Reference values)

**AZM66 Gear Ratio 5**

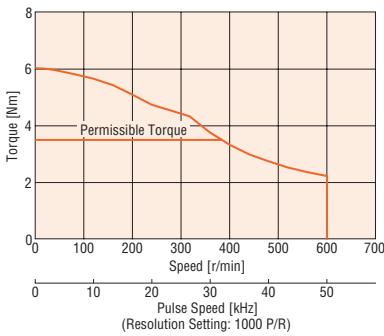

**AZM66 Gear Ratio 7.2**

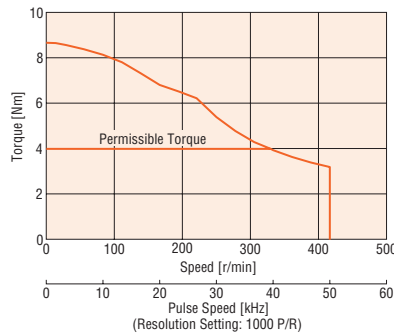

**AZM66 Gear Ratio 10**

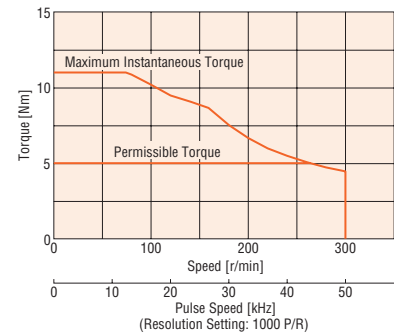

**AZM66 Gear Ratio 25**

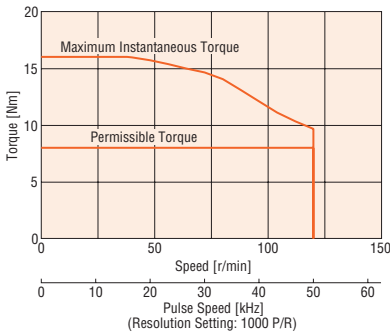

**AZM66 Gear Ratio 36**

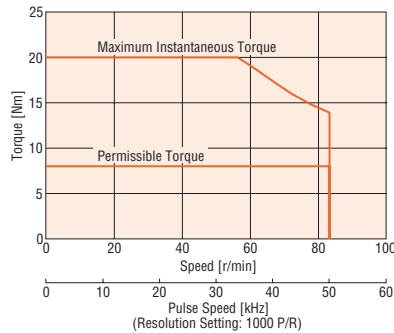

**AZM66 Gear Ratio 50**

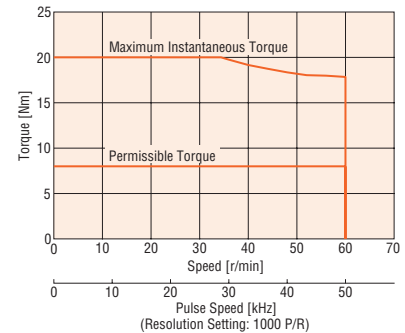

### Note

- Data for the speed – torque characteristics is based on Oriental Motor's internal measurement conditions. If the conditions are changed, the characteristics may also change as a result.
- Depending on the driving conditions, a considerable amount of heat may be generated by the motor. To protect the absolute sensor, be sure to keep the temperature of the motor case at 80°C or less. (When conforming to the UL or CSA Standards, the temperature of the motor case must be kept at 75°C or less since the motor is recognized as heat-resistant class A.)
- For SSCNETIII/H compatible drivers, the resolution is fixed at 10,000 P/R.



# Harmonic Geared Type Frame Size 42 mm, 60 mm

## Specifications



Motor Product Name	Single Shaft	<b>AZM46ACH-HS50</b>	<b>AZM46ACH-HS100</b>	<b>AZM66ACH-HS50</b>	<b>AZM66ACH-HS100</b>
Driver Product Name	With Electromagnetic Brake	<b>AZM46MCH-HS50</b>	<b>AZM46MCH-HS100</b>	<b>AZM66MCH-HS50</b>	<b>AZM66MCH-HS100</b>
		<b>AZD-A</b> , <b>AZD-C</b>			
Max. Holding Torque	Nm	3.5	5	7	10
Rotor Inertia	J: kgm <sup>2</sup>	72×10 <sup>-7</sup> (88×10 <sup>-7</sup> )*1		405×10 <sup>-7</sup> (565×10 <sup>-7</sup> )*1	
Gear Ratio		50	100	50	100
Resolution	Resolution Setting: 1000 P/R *2	0.0072°/Pulse	0.0036°/Pulse	0.0072°/Pulse	0.0036°/Pulse
Permissible Torque	Nm	3.5	5	7	10
Max. Instantaneous Torque*	Nm	8.3	11	23	36
Holding Torque at Power ON	Nm	3.5	5	7	10
Motor Standstill Electromagnetic Brake	Nm	3.5	5	7	10
Permissible Speed Range	r/min	0~70	0~35	0~70	0~35
Lost Motion (Load torque)	arcmin	1.5 max. (±0.16 Nm)	1.5 max. (±0.20 Nm)	0.7 max. (±0.28 Nm)	0.7 max. (±0.39 Nm)
Power Supply Input	Check "Driver Specifications" on page 18 for the driver current when combined with a motor.				
Control Power Supply					

● A letter indicating the driver type is specified where the box **■** is located in the product name. Check "List of Combinations" on page 9 for driver product names.

\* For the geared motor output torque, refer to the speed-torque characteristics.

\*1 The value inside the ( ) represents the value when connecting an electromagnetic brake motor.

\*2 For SSCNETIII/H compatible drivers, the resolution is fixed at 10,000 P/R.

### Note

● The rotor inertia represents a sum of the inertia of the harmonic gear converted to motor shaft values.

## Speed – Torque Characteristics (Reference values)

**AZM46 Gear Ratio 50**

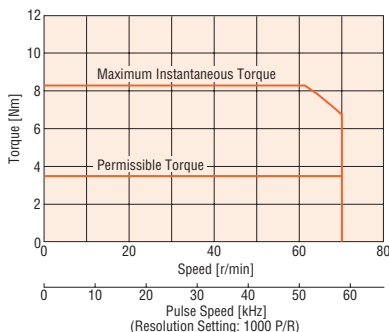

**AZM66 Gear Ratio 50**

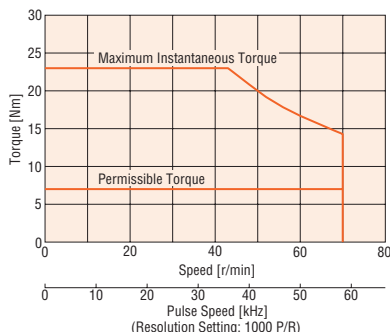

**AZM46 Gear Ratio 100**

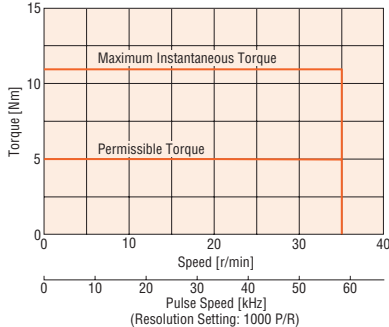

**AZM66 Gear Ratio 100**

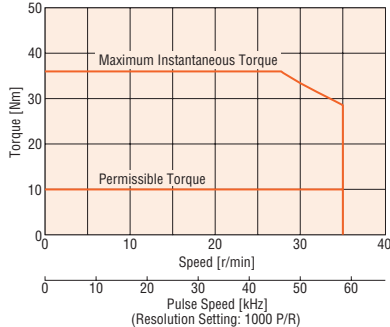

### Note

● Data for the speed – torque characteristics is based on Oriental Motor's internal measurement conditions. If the conditions are changed, the characteristics may also change as a result.

● Depending on the driving conditions, a considerable amount of heat may be generated by the motor. To protect the absolute sensor, be sure to keep the temperature of the motor case at 80°C or less. (When conforming to the UL or CSA Standards, the temperature of the motor case must be kept at 75°C or less since the motor is recognized as heat-resistant class A.)

● For SSCNETIII/H compatible drivers, the resolution is fixed at 10,000 P/R.

System Configuration

Product Line

Specifications and Characteristics

Dimensions

System Configuration

Product Line

Specifications and Characteristics

Dimensions

Cable

## Driver Specifications

Driver Product Name		AZD-AED AZD-AEP AZD-APN AZD-AX AZD-A	AZD-CED AZD-CEP AZD-CPN AZD-CX AZD-C		
Main Power Supply	Input Voltage	Single-phase 100-120 VAC -15~+6% 50/60 Hz	Single-phase 200-240 VAC -15~+6% 50/60 Hz	Three-phase 200-240 VAC -15~+6% 50/60 Hz	
	Input Current	<b>AZM46</b>	2.7 A	1.7 A	1.0 A
		<b>AZM48</b>	2.7 A	1.6 A	1.0 A
		<b>AZM66</b>	3.8 A	2.3 A	1.4 A
		<b>AZM69</b>	5.4 A	3.3 A	2.0 A
Control Power Supply	Input Voltage	24 VDC±5%			
	Input Current	0.25 A (0.5 A)*			
Interface	Pulse Input	<ul style="list-style-type: none"> <li>· 2 Points, Photocoupler</li> <li>· Max. Input Pulse Frequency Line Driver: 1 MHz (at 50% duty) Open Collector: 250 kHz (at 50% duty)</li> </ul>			
	Control Input	6 Points, Photocoupler			
	Pulse Output	2 Points, Line Driver			
	Control Output	6 Points, Photocoupler and Open-Collector			
	Power Shut Down Signal Input	2 Points, Photocoupler			
	Power Shut Down Monitor Output	1 Points, Photocoupler and Open-Collector			

\* The value inside the ( ) represents the value when an electromagnetic brake motor is connected. **AZM46** is 0.33 A.

Driver Product Name		AZD-AM3 AZD-AS3	AZD-CM3 AZD-CS3		AZD-AD	AZD-CD		
Main Power Supply	Input Voltage	Single-phase 100-120 VAC -15~+6% 50/60 Hz	Single-phase 200-240 VAC -15~+6% 50/60 Hz	Three-phase 200-240 VAC -15~+6% 50/60 Hz	Single-phase 100-120 VAC -15~+6% 50/60 Hz	Single-phase 200-240 VAC -15~+6% 50/60 Hz	Three-phase 200-240 VAC -15~+6% 50/60 Hz	
	Input Current	<b>AZM46</b>	2.7 A	1.7 A	1.0 A	2.7 A	1.7 A	1.0 A
		<b>AZM48</b>	2.7 A	1.6 A	1.0 A	2.7 A	1.6 A	1.0 A
		<b>AZM66</b>	3.8 A	2.3 A	1.4 A	3.8 A	2.3 A	1.4 A
		<b>AZM69</b>	5.4 A	3.3 A	2.0 A	5.4 A	3.3 A	2.0 A
Control Power Supply	Input Voltage	24 VDC±5%						
	Input Current	0.25 A (0.5 A)*						
Interface	Control Input	4 Points, Photocoupler			10 Points, Photocoupler			
	Pulse Output	-			2 Points, Line Driver			
	Control Output	3 Points, Photocoupler and Open-Collector			6 Points, Photocoupler and Open-Collector			
	Power Shut Down Signal Input	2 Points, Photocoupler						
	Power Shut Down Monitor Output	1 Points, Photocoupler and Open-Collector						

\* The value inside the ( ) represents the value when an electromagnetic brake motor is connected. **AZM46** is 0.33 A.

## General Specifications

	Motor	Driver	
		EtherCAT Driver Profile-Compatible EtherNet/IP-Compatible PROFINET-Compatible Built-in Positional Function Type Pulse Input Type with RS-485 Communication	MECHATROLINK- Compatible SSCNET /H-Compatible Pulse Input Type
Thermal Class	130 (B) [UL/CSA is certified as compliant with 105 (A)]	—	
Insulation Resistance	100 MΩ or more when a 500 VDC megger is applied between the following places: • Case–Motor Winding • Case–Electromagnetic Brake Winding*1	100 MΩ or more when a 500 VDC megger is applied between the following places: • Protective Earth Terminal–Main Power Supply Terminal • Encoder Connector–Main Power Supply Terminal • I/O Signal Terminal–Main Power Supply Terminal	
Dielectric Strength	Sufficient to withstand the following for 1 minute: • Between the case and motor windings: 1.5 kVAC, 50 Hz or 60 Hz • Between the case and electromagnetic brake windings*1: 1.5 kVAC, 50 Hz or 60 Hz	Sufficient to withstand the following for 1 minute: • Protective Earth Terminal–Main Power Supply Terminal 1.5 kVAC, 50 Hz or 60 Hz • Encoder Connector–Main Power Supply Terminal 1.8 kVAC, 50 Hz or 60 Hz • I/O Signal Terminal–Main Power Supply Terminal 1.8 kVAC, 50 Hz or 60 Hz	
Operating Environment (In operation)	Ambient Temperature	0~+40°C (Non-Freezing)*2	
	Ambient Humidity	85% or less (Non-Condensing)	
	Altitude	Max. 1000 m above sea level	
	Atmosphere	No corrosive gases or dust. The product should not be exposed to water, oil or other liquids.	
Degree of Protection	IP66 when a connection cable has been attached (excludes installation surface and the connector on the driver side of the connection)	IP10	IP20
Stop Position Accuracy	<b>AZM46, AZM48:</b> ±4 minutes (±0.067°) <b>AZM66, AZM69:</b> ±3 minutes (±0.05°)		
Shaft Runout	0.05T.I.R. (mm)*4	—	
Concentricity of Installation Pilot to the Shaft	0.075T.I.R. (mm)*4	—	
Perpendicularity of Installation Surface to the Shaft	0.075T.I.R. (mm)*4	—	
Multiple Rotation Detection Range in Power OFF State	±900 Rotation (1800 Rotations)		

\*1 Only for products with an electromagnetic brake

\*2 Based on Oriental Motor's internal measurement conditions

\*3 When a heat sink of a capacity at least equivalent to an aluminum plate with a size of 200×200 mm and 2 mm thickness

\*4 T.I.R. (Total Indicator Reading): The total dial gauge reading when the measurement section is rotated once around the reference axis center.

### Note

- When measuring insulation resistance or performing dielectric voltage withstand test, disconnect the motor and driver.  
Also, do not perform these tests on the ABZO Sensor (Absolute Sensor) part of the motor.

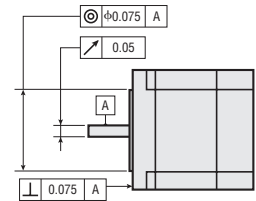

## Electromagnetic Brake Specifications

Product Name	AZM46	AZM66	AZM69
Type	Power Off Activated Type		
Power Supply Voltage	24 VDC±5%		
Power Supply Current	A 0.08	0.25	0.25
Time Rating	Continuous		

## Rotation Direction

This indicates the rotation direction when viewed from the output shaft side of the motor.

The rotation direction of the output gear shaft relative to the standard type motor output shaft varies depending on the gear type and gear ratio.

Please check the following table.

Type	Gear Ratio	Rotation Direction when Viewed from the Output Shaft Side of the Motor
<b>TS</b> Geared Type	<b>3.6, 7.2, 10</b>	Same Direction
	<b>20, 30</b>	Opposite Direction
<b>FC</b> Geared Type	Total Gear Ratio	Same Direction
<b>PS</b> Geared Type	Total Gear Ratio	Opposite Direction

### ● Standard Type Motor

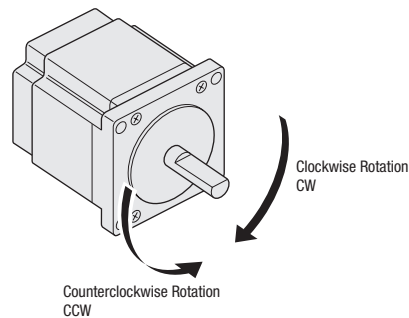

# Permissible Radial Load and Permissible Axial Load

Unit: N

Type	Motor Frame Size	Product Name	Gear Ratio	Permissible Radial Load					Permissible Axial Load
				Distance from Shaft End [mm]					
				0	5	10	15	20	
Standard Type	42 mm	<b>AZM46</b>	-	35	44	58	85	-	15
		<b>AZM48</b>		30	35	44	58	85	
	60 mm	<b>AZM66, AZM69</b>		90	100	130	180	270	30
TS Geared Type	42 mm	<b>AZM46</b>	<b>3.6, 7.2, 10</b>	20	30	40	50	-	15
			<b>20, 30</b>	40	50	60	70	-	
	60 mm	<b>AZM66</b>	<b>3.6, 7.2, 10</b>	120	135	150	165	180	40
			<b>20, 30</b>	170	185	200	215	230	
FC Geared Type	42 mm	<b>AZM46</b>	<b>7.2, 10, 20, 30</b>	180	200	220	250	-	100
	60 mm	<b>AZM66</b>		270	290	310	330	350	200
PS Geared Type	42 mm	<b>AZM46</b>	<b>5</b>	70	80	95	120	-	100
			<b>7.2</b>	80	90	110	140	-	
			<b>10</b>	85	100	120	150	-	
			<b>25</b>	120	140	170	210	-	
			<b>36</b>	130	160	190	240	-	
			<b>50</b>	150	170	210	260	-	
	60 mm	<b>AZM66</b>	<b>5</b>	170	200	230	270	320	200
			<b>7.2</b>	200	220	260	310	370	
			<b>10</b>	220	250	290	350	410	
			<b>25</b>	300	340	400	470	560	
			<b>36</b>	340	380	450	530	630	
			<b>50</b>	380	430	500	600	700	
Harmonic Geared Type	42 mm	<b>AZM46</b>	<b>50, 100</b>	180	220	270	360	510	220
	60 mm	<b>AZM66</b>		320	370	440	550	720	450

- The product names are listed such that the product names are distinguishable.
- The **PS** geared type has a full lifespan of 20,000 hours when either the permissible radial load or the permissible axial load is applied. For the life of gearhead, please contact the nearest Oriental Motor sales office, or visit the Oriental Motor website.

## Radial Load and Axial Load

Distance from Shaft End [mm]

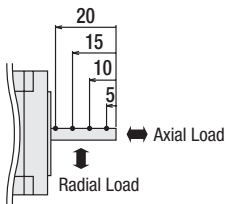

## Permissible Moment Load

If an eccentric load is applied to the output flange-installation surface, load moment acts on the bearing. Confirm before use that the axial load and load moment are within specification with the following formulas.

### Harmonic Geared Type

Motor Frame Size	Permissible Axial Load [N]	Permissible Moment Load [Nm]	Constant $\alpha$ [m]
42 mm	220	5.6	0.009
60 mm	450	11.6	0.0114

The permissible moment load can be calculated with the following formula.

**Example 1: External force F (N) applied to the overhung position L [m] in a horizontal direction from the center of the output flange**

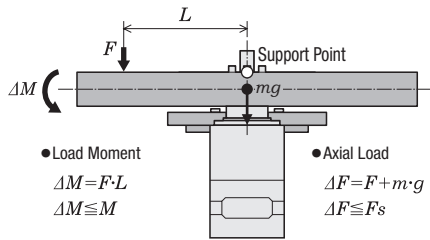

**Example 2: External force F (N) applied to the overhung position L [m] in a vertical direction from the installation surface of the output flange**

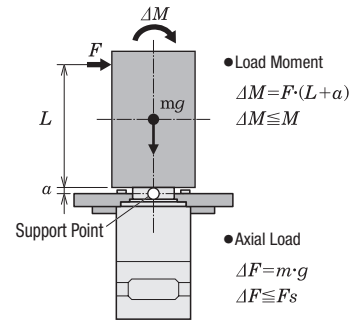

# Harmonic Geared Type Accuracy

## Principle and Structure

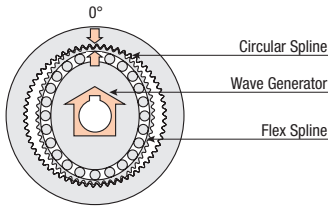

## Accuracy

Unlike the conventional spur gear gearhead, the harmonic gear has no backlash. The harmonic gear has many teeth in simultaneous meshing engagement, and is designed to average out the effects of tooth pitch error and cumulative pitch error on rotation accuracy to ensure high positioning accuracy. Also, harmonic gears have high gear ratio, so that the torsion when the load torque is applied to the output shaft is much smaller than a single motor and other geared motor, and the rigidity is high. High rigidity is less subject to load fluctuation and enables stable positioning. When the high positioning accuracy and rigidity are required, refer to the following characteristics.

### Angular Transmission Accuracy

Angular transmission error is the difference between the theoretical rotation angle of the output shaft, as calculated from the input pulse count, and actual rotation angle. Represented as the difference between the min. value and max. value in the set of measurements taken for a single rotation of the output shaft, starting from an arbitrary position.

Product Name	Angular Transmission Accuracy [arcmin]
<b>AZM46-HS</b> □	1.5 (0.025°)
<b>AZM66-HS</b> □	

● Values under no load conditions (gear reference values)

### Torque – Torsion Characteristics

In actual applications, there is always frictional load, and displacement is produced as a result of this frictional load. If the frictional load is constant, the displacement will be constant for unidirectional operation. However, in bidirectional operation, double the displacement is produced over a round trip. This displacement can be estimated from the following torque – torsion characteristics.

This displacement occurs when an external force is applied as the gear is stopped, or when the gear is driven under a frictional load. The slope can be approximated with the spring constant in the following 3 classes, depending on the size of the load torque, and can be estimated through calculation.

1. Load torque  $T_L$  is  $T_1$  max.

$$\theta = \frac{T_L}{K_1} \text{ [min]}$$

2. Load torque  $T_L$  exceeds  $T_1$  but is less than  $T_2$

$$\theta = \theta_1 + \frac{T_L - T_1}{K_2} \text{ [min]}$$

3. Load torque  $T_L$  exceeds  $T_2$

$$\theta = \theta_2 + \frac{T_L - T_2}{K_3} \text{ [min]}$$

The torsion angle of the harmonic gear alone is calculated according to the size of the load torque.

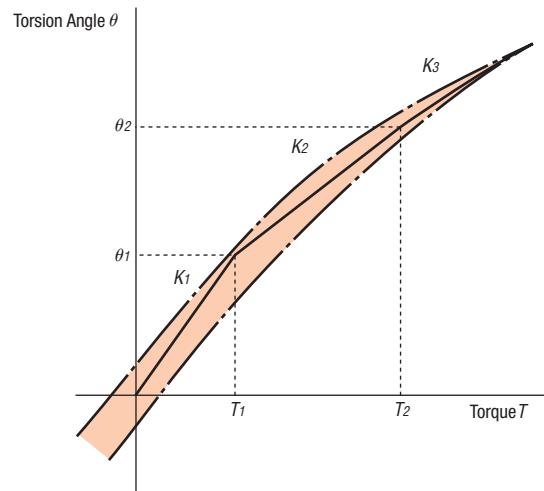

Torsion Angle – Torque Characteristics

### Values for Determining Torsion Angle

Product Name	Gear Ratio	T1 Nm	K1 Nm/min	$\theta_1$ min	T2 Nm	K2 Nm/min	$\theta_2$ min	K3 Nm/min
<b>AZM46-HS50</b>	50	0.8	0.64	1.25	2	0.87	2.6	0.93
<b>AZM46-HS100</b>	100	0.8	0.79	1.02	2	0.99	2.2	1.28
<b>AZM66-HS50</b>	50	2	0.99	2	6.9	1.37	5.6	1.66
<b>AZM66-HS100</b>	100	2	1.37	1.46	6.9	1.77	4.2	2.1

## Dimensions (Unit: mm)

### ● Motor

#### ◇ Standard Type

Frame Size 42 mm

Shaft Type	Product Name	Mass [kg]
Single Shaft Flat Type	<b>AZM46ACH</b>	0.4
Straight Type	<b>AZM46A0CH</b>	

Single Shaft Flat Type

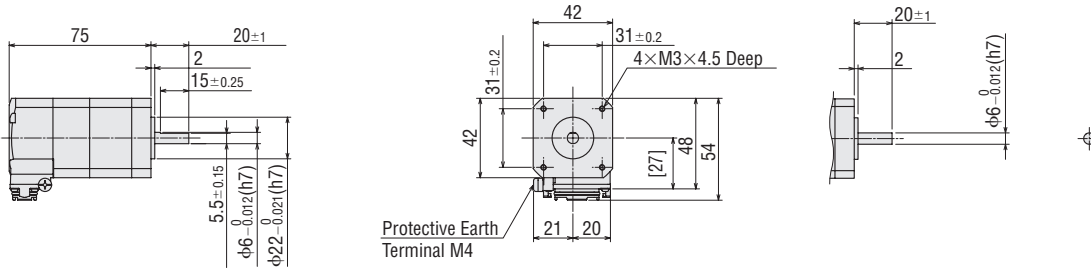

### ● With Connection Cable Attached

Cable Drawn in the Same Direction As the Output Shaft

Cable Drawn Vertically

Cable Drawn in the Opposite Direction of the Output Shaft

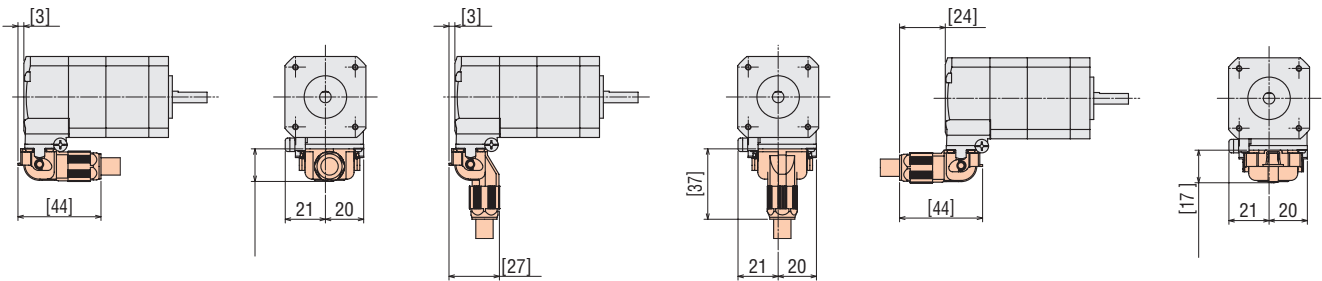

Shaft Type	Product Name	Mass [kg]
Single Shaft Flat Type	<b>AZM48ACH</b>	0.63
Straight Type	<b>AZM48A0CH</b>	
Key Shaft Type	<b>AZM48A1CH</b>	

Single Shaft Flat Type

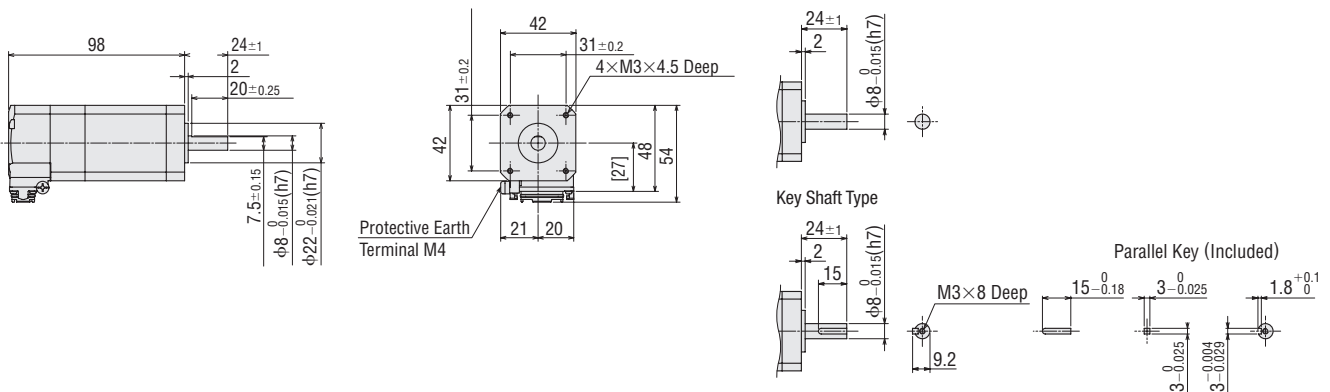

### ● With Connection Cable Attached

Cable Drawn in the Same Direction As the Output Shaft

Cable Drawn Vertically

Cable Drawn in the Opposite Direction of the Output Shaft

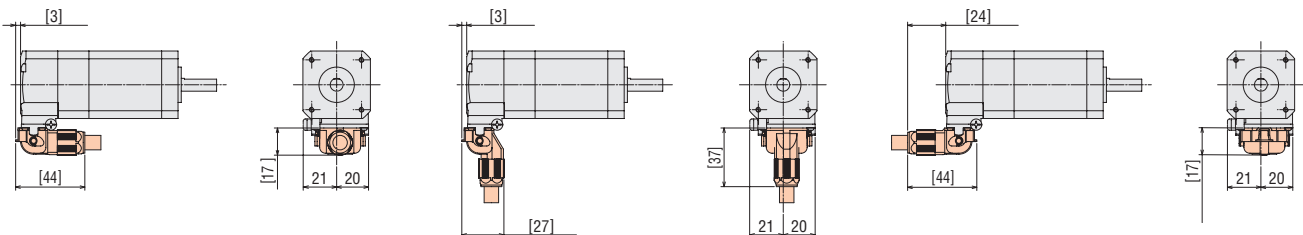

● The color in the dimensions indicates the connection cable that is sold separately.

## Frame Size 60 mm

Shaft Type	Product Name	L	Mass [kg]
Single Shaft Flat Type	<b>AZM66ACH</b>	74.5	0.84
Straight Type	<b>AZM66A0CH</b>		
Key Type	<b>AZM66A1CH</b>		
Single Shaft Flat Type	<b>AZM69ACH</b>	100	1.3
Straight Type	<b>AZM69A0CH</b>		
Key Type	<b>AZM69A1CH</b>		

### Single Shaft Flat Type

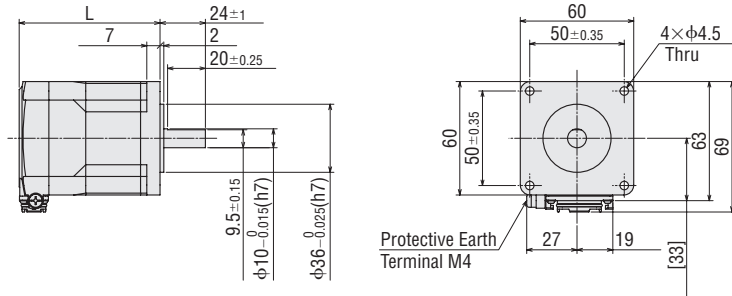

### Straight Type

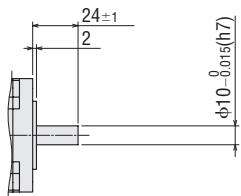

### Key Type

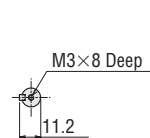
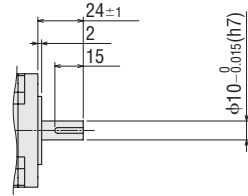

### Parallel Key (Included)

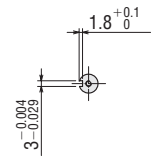
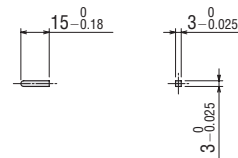

### ● With Connection Cable Attached

#### Cable Drawn in the Same Direction As the Output Shaft

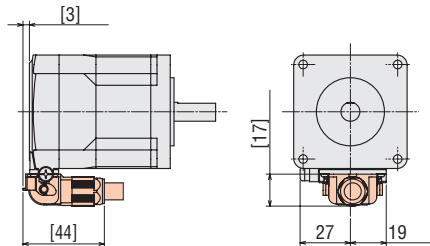

#### Cable Drawn Vertically

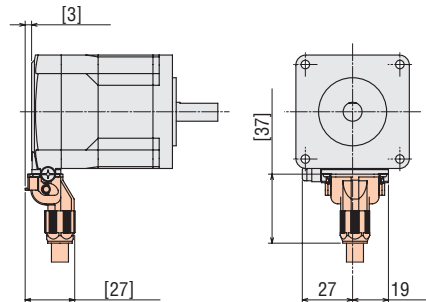

#### Cable Drawn in the Opposite Direction of the Output Shaft

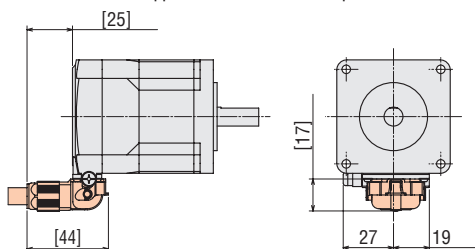

● The color in the dimensions indicates the connection cable that is sold separately.



◇ Standard Type with Electromagnetic Brake  
Frame Size 42 mm

Shaft Type	Product Name	Mass [kg]
Single Shaft Flat Type	<b>AZM46MCH</b>	0.54
Straight Type	<b>AZM46MOCH</b>	

Single Shaft Flat Type

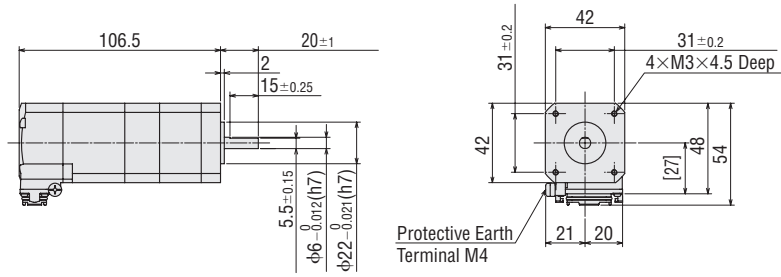

Straight Type

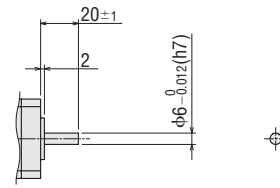

● With Connection Cable Attached

Cable Drawn in the Same Direction As the Output Shaft

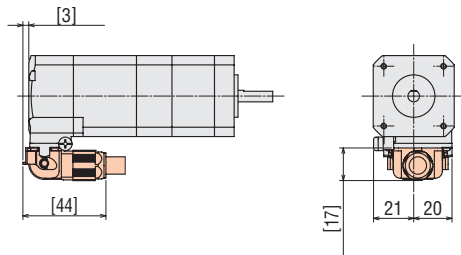

Cable Drawn Vertically

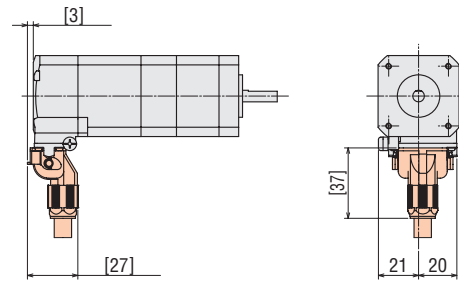

Cable Drawn in the Opposite Direction of the Output Shaft

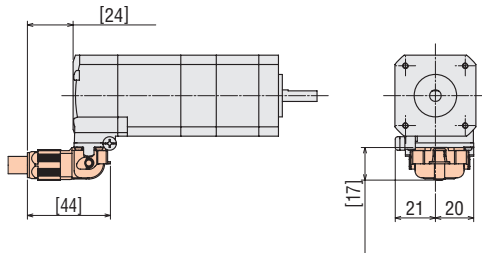

● The color in the dimensions indicates the connection cable that is sold separately.

System Configuration	AC Input	System Configuration
Product Line	Specifications and Characteristics	Product Line
Dimensions	Dimensions	Dimensions
System Configuration	DC Input	System Configuration
Product Line	Specifications and Characteristics	Product Line
Dimensions	Dimensions	Dimensions
Cable		Cable

## Frame Size 60 mm

Shaft Type	Product Name	L	Mass [kg]
Single Shaft Flat Type	<b>AZM66MCH</b>	120	1.2
Straight Type	<b>AZM66M0CH</b>		
Key Type	<b>AZM66M1CH</b>		
Single Shaft Flat Type	<b>AZM69MCH</b>	145.5	1.7
Straight Type	<b>AZM69M0CH</b>		
Key Type	<b>AZM69M1CH</b>		

### Single Shaft Flat Type

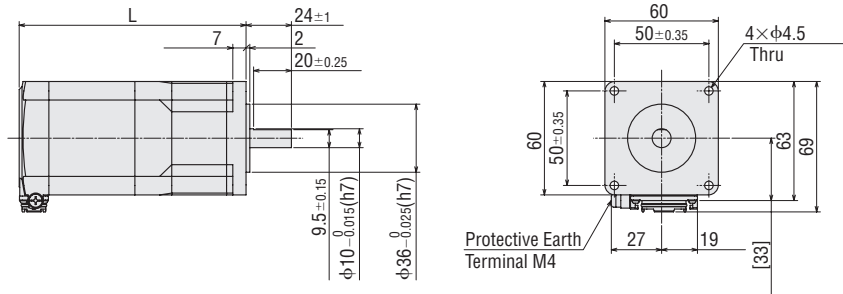

### Straight Type

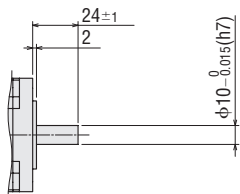

### Key Type

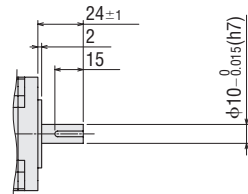

### Parallel Key (Included)

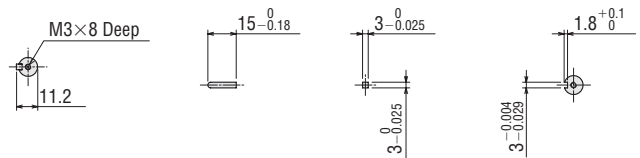

### ● With Connection Cable Attached

#### Cable Drawn in the Same Direction as the Output Shaft

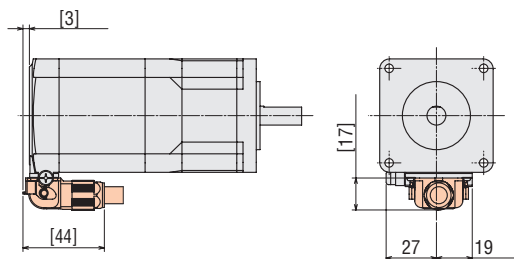

#### Cable Drawn Vertically

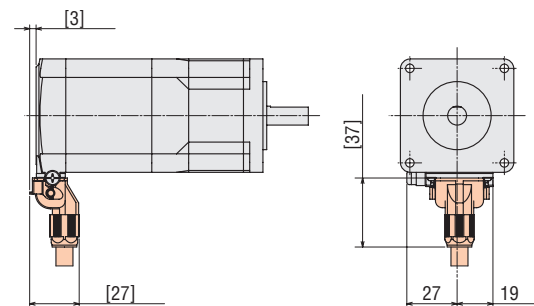

#### Cable Drawn in the Opposite Direction of the Output Shaft

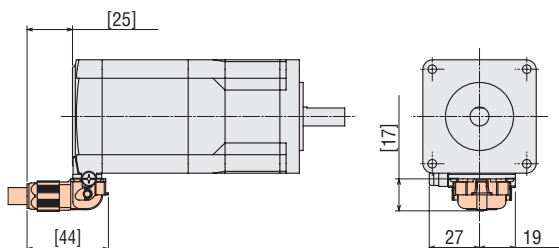

● The color in the dimensions indicates the connection cable that is sold separately.

◇ **TS Geared Type**

**Frame Size 42 mm**

Connector Direction	Product Name	Gear Ratio	Mass [kg]
Down Side	<b>AZM46ACH-TS</b> <span style="background-color: #cccccc; border: 1px solid black; padding: 0 2px;"> </span>	<b>3.6, 7.2, 10, 20, 30</b>	0.55
Right Side	<b>AZM46ACH-TS</b> <span style="background-color: #cccccc; border: 1px solid black; padding: 0 2px;">R</span>		
Upper Side	<b>AZM46ACH-TS</b> <span style="background-color: #cccccc; border: 1px solid black; padding: 0 2px;">U</span>		
Left Side	<b>AZM46ACH-TS</b> <span style="background-color: #cccccc; border: 1px solid black; padding: 0 2px;">L</span>		

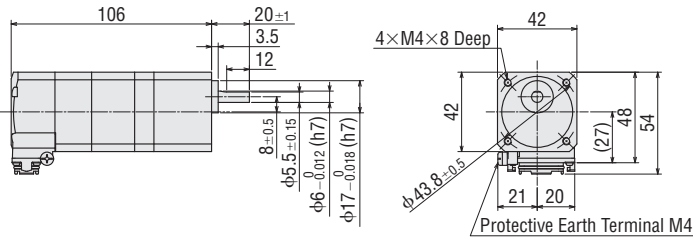

● **Connector Direction**

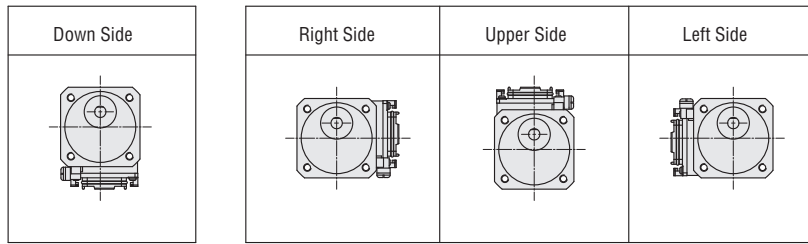

● **When the Connection Cable is Attached**  
Cable Outlet in Output Shaft Direction

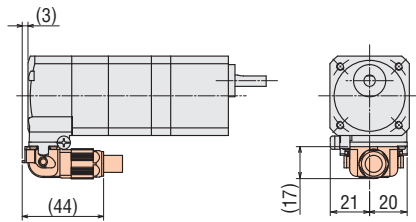

Cable Outlet in Vertical Direction

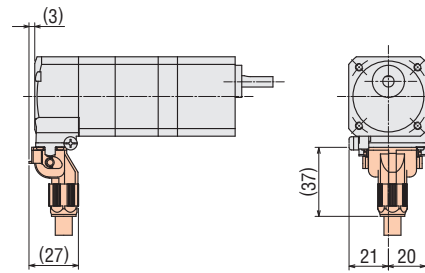

Cable Outlet Opposite to Output Shaft Direction

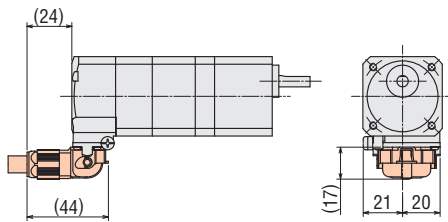

- A number indicating the gear ratio is entered where the box   is located within the product name.
- The shaded   areas are the separately sold connection cables.

### Frame Size 60 mm

Connector Direction	Product Name	Gear Ratio	Mass [kg]
Down Side	<b>AZM66ACH-TS</b> <span style="background-color: #cccccc; border: 1px solid black; padding: 0 2px;"> </span>	<b>3.6, 7.2, 10, 20, 30</b>	1.2
Right Side	<b>AZM66ACH-TS</b> <span style="background-color: #cccccc; border: 1px solid black; padding: 0 2px;">R</span>		
Upper Side	<b>AZM66ACH-TS</b> <span style="background-color: #cccccc; border: 1px solid black; padding: 0 2px;">U</span>		
Left Side	<b>AZM66ACH-TS</b> <span style="background-color: #cccccc; border: 1px solid black; padding: 0 2px;">L</span>		

● Mounting Screws: M4×60 P0.7 (4 pieces included)

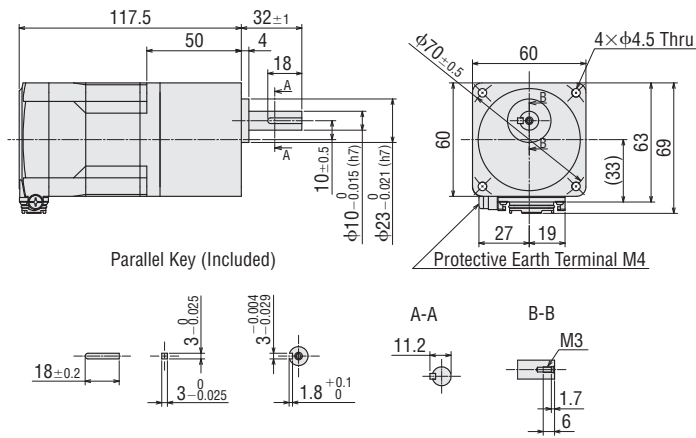

### ● Connector Direction

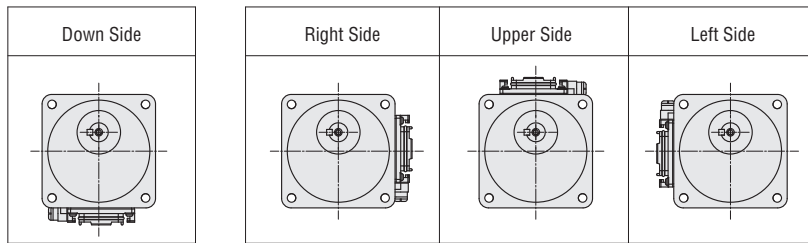

### ● When the Connection Cable is Attached

Cable Outlet in Output Shaft Direction

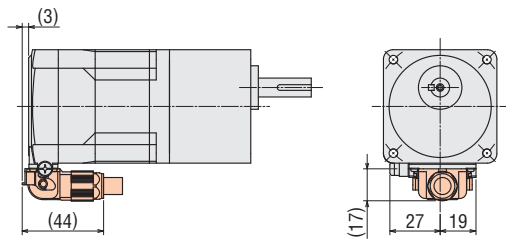

Cable Outlet in Vertical Direction

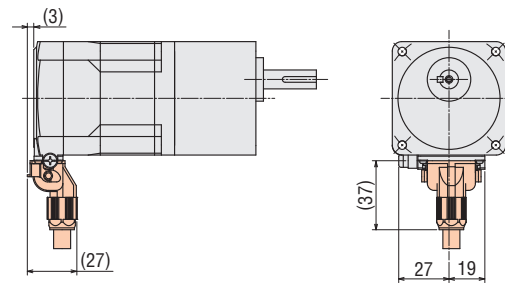

Cable Outlet Opposite to Output Shaft Direction

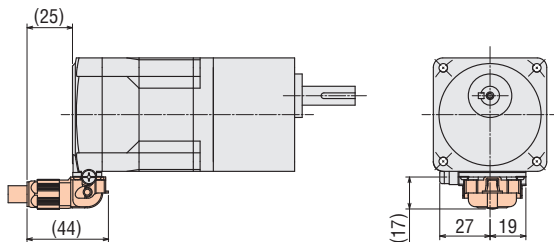

- A number indicating the gear ratio is entered where the box   is located within the product name.
- The shaded   areas are the separately sold connection cables.



Frame Size 60 mm

Connector Direction	Product Name	Gear Ratio	Mass [kg]
Down Side	<b>AZM66MCH-TS</b> <span style="border: 1px solid black; padding: 0 2px;"> </span>	<b>3.6, 7.2, 10, 20, 30</b>	1.6
Right Side	<b>AZM66MCH-TS</b> <span style="border: 1px solid black; padding: 0 2px;">R</span>		
Upper Side	<b>AZM66MCH-TS</b> <span style="border: 1px solid black; padding: 0 2px;">U</span>		
Left Side	<b>AZM66MCH-TS</b> <span style="border: 1px solid black; padding: 0 2px;">L</span>		

● Mounting Screws: M4×60 P0.7 (4 pieces included)

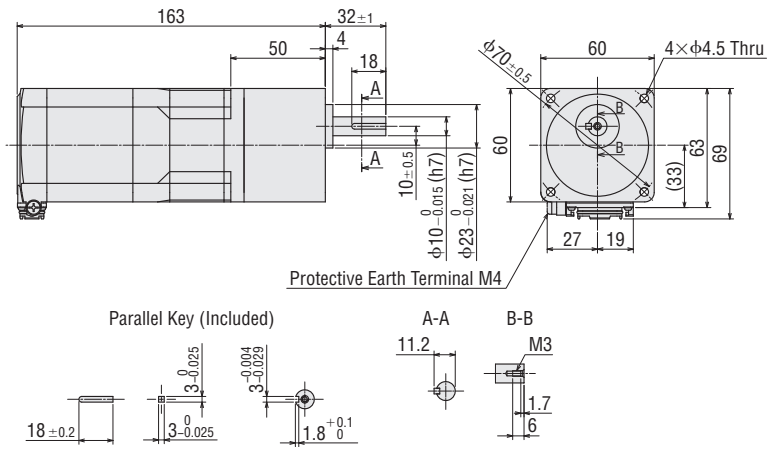

● Connector Direction

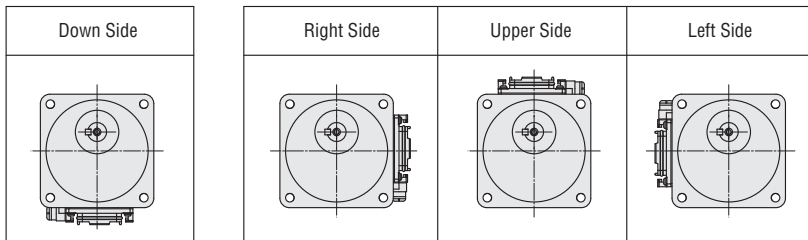

● When the Connection Cable is Attached

Cable Outlet in Output Shaft Direction

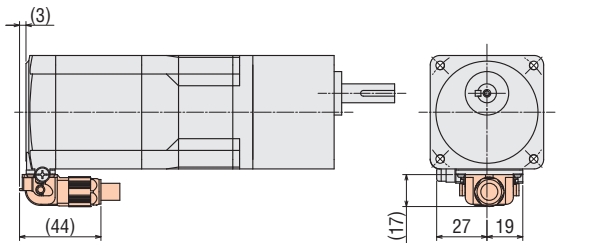

Cable Outlet in Vertical Direction

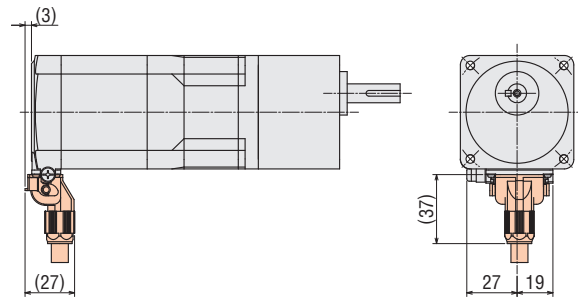

Cable Outlet Opposite to Output Shaft Direction

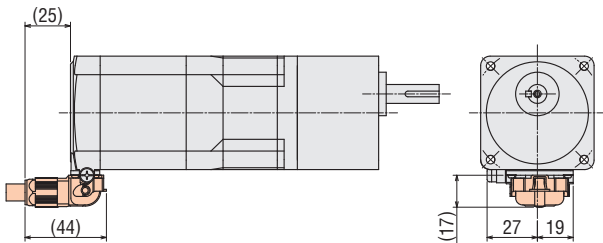

- A number indicating the gear ratio is entered where the box   is located within the product name.
- The shaded  areas are the separately sold connection cables.

◇FC Geared Type

Frame Size 42 mm Connector Direction Upper Side

Product Name	Gear Ratio	Mass [kg]
<b>AZM46ACH-FC■UA</b>	<b>7.2, 10, 20, 30</b>	0.75

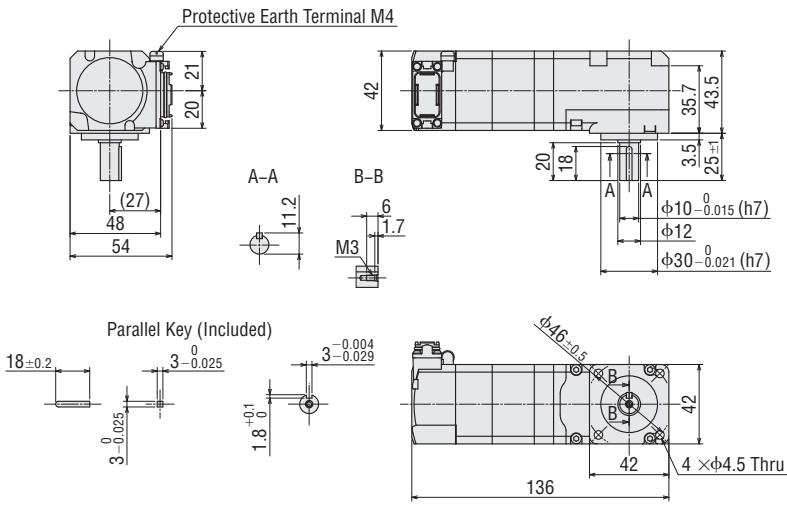

● When the Connection Cable is Attached

Cable Outlet in Output Shaft Direction

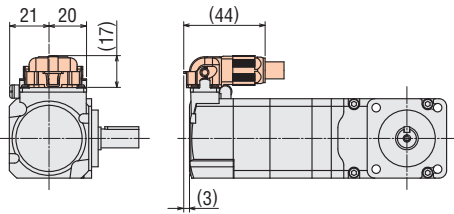

Cable Outlet in Vertical Direction

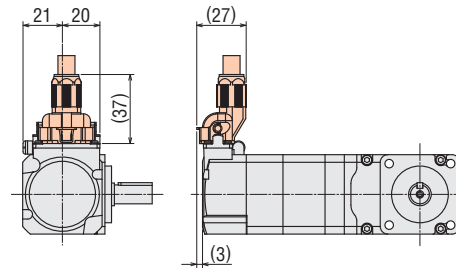

Cable Outlet Opposite to Output Shaft Direction

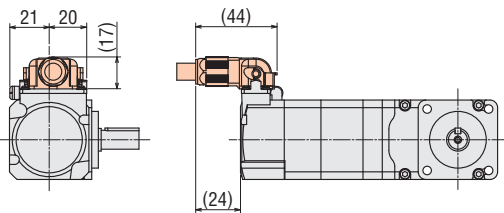

● A number indicating the gear ratio is entered where the box ■ is located within the product name.  
 ● The shaded areas are the separately sold connection cables.

Frame Size 42 mm Connector Direction Down Side

Product Name	Gear Ratio	Mass [kg]
<b>AZM46ACH-FC</b> <span style="background-color: #cccccc; border: 1px solid black; padding: 0 2px;"> </span> <b>DA</b>	<b>7.2, 10, 20, 30</b>	0.75

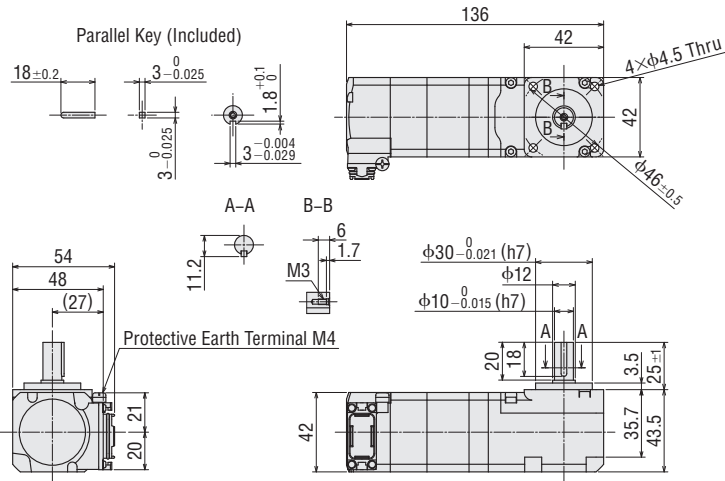

● When the Connection Cable is Attached

Cable Outlet in Output Shaft Direction

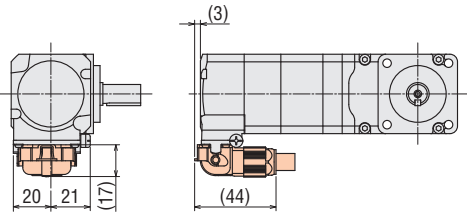

Cable Outlet in Vertical Direction

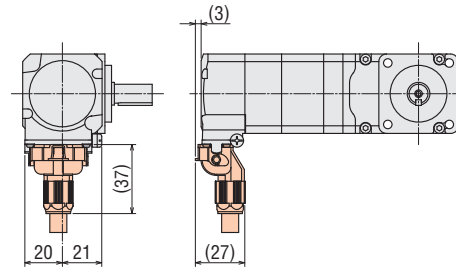

Cable Outlet Opposite to Output Shaft Direction

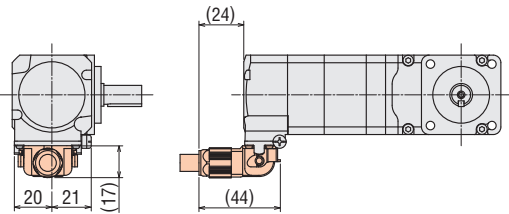

● A number indicating the gear ratio is entered where the box   is located within the product name.  
 ● The shaded   areas are the separately sold connection cables.



Frame Size 60 mm Connector Direction Upper Side

Product Name	Gear Ratio	Mass [kg]
<b>AZM66ACH-FC</b> <span style="border: 1px solid black; padding: 0 2px;"> </span> <b>UA</b>	<b>7.2, 10, 20, 30</b>	1.7

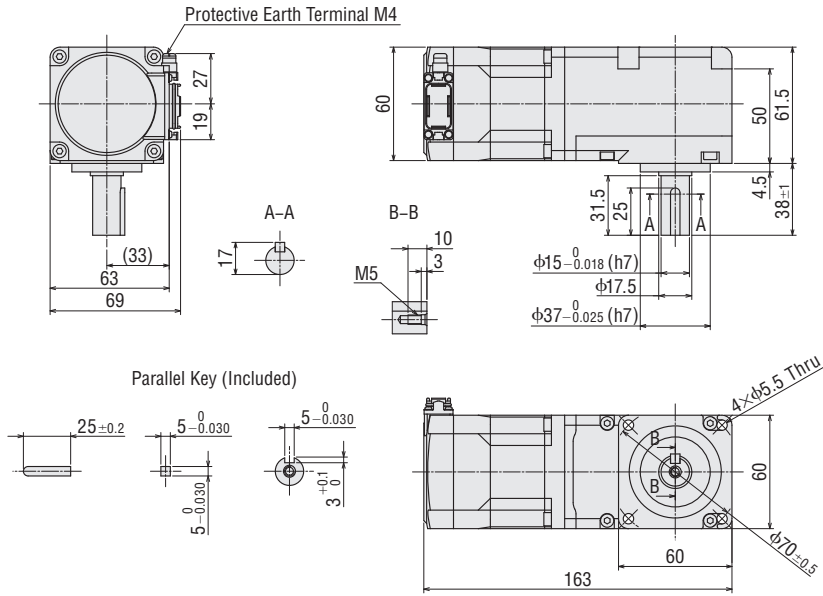

● When the Connection Cable is Attached

Cable Outlet in Output Shaft Direction

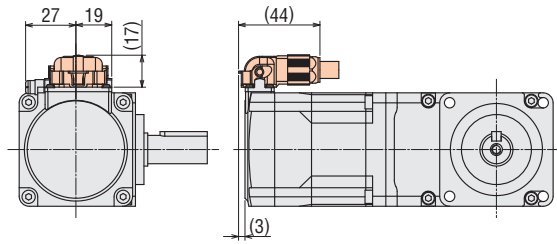

Cable Outlet in Vertical Direction

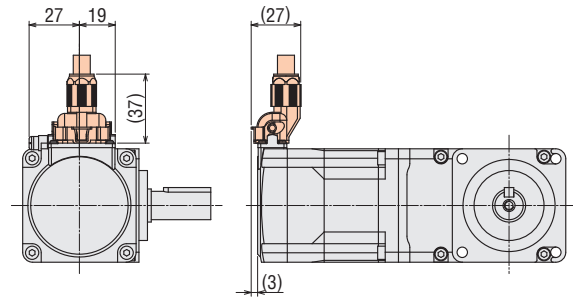

Cable Outlet Opposite to Output Shaft Direction

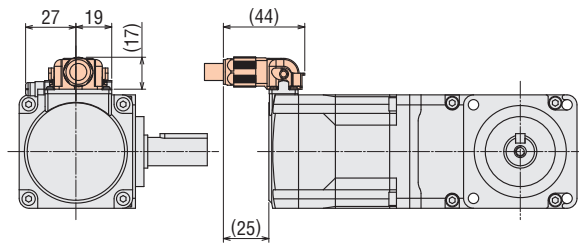

- A number indicating the gear ratio is entered where the box   is located within the product name.
- The shaded  areas are the separately sold connection cables.

System Configuration	AC Input	System Configuration
Product Line	Specifications and Characteristics	Product Line
Dimensions	DC Input	Specifications and Characteristics
		Dimensions
		Cable

Frame Size 60 mm Connector Direction Down Side

Product Name	Gear Ratio	Mass [kg]
AZM66ACH-FC <span style="border: 1px solid black; padding: 0 2px;"> </span> DA	7.2, 10, 20, 30	1.7

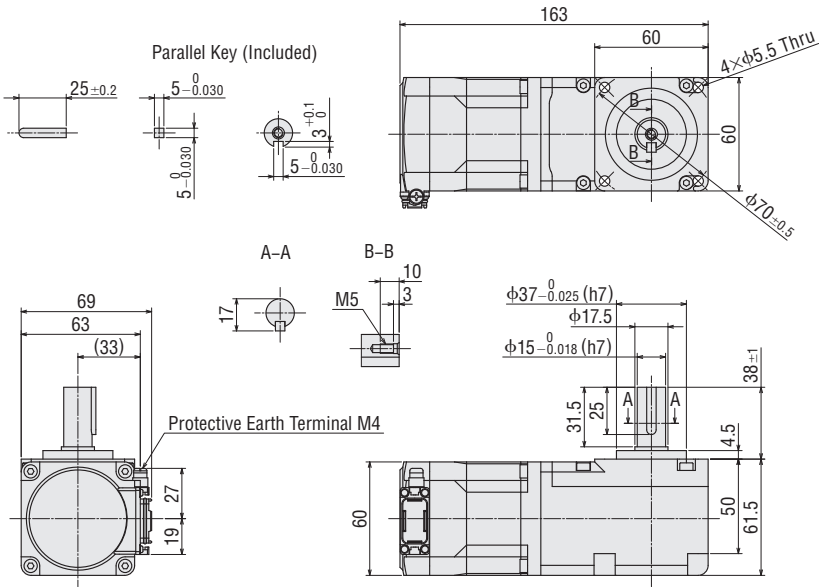

● When the Connection Cable is Attached

Cable Outlet in Output Shaft Direction

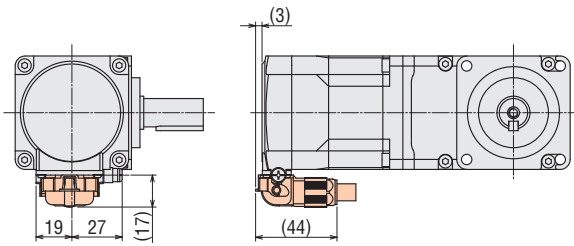

Cable Outlet in Vertical Direction

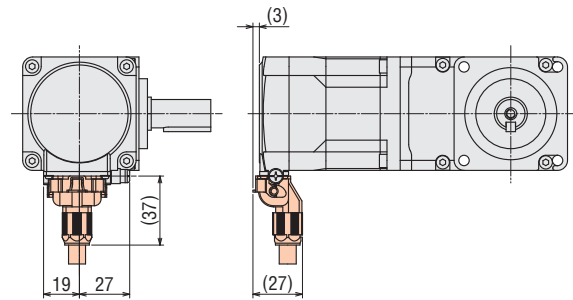

Cable Outlet Opposite to Output Shaft Direction

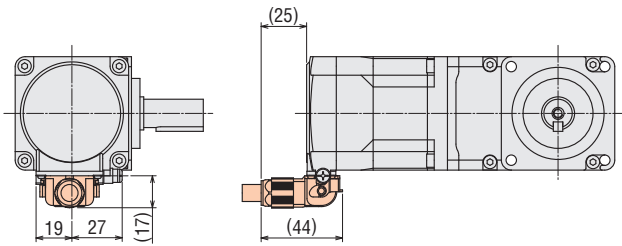

- A number indicating the gear ratio is entered where the box   is located within the product name.
- The shaded  areas are the separately sold connection cables.

◇FC Geared Type with Electromagnetic Brake  
 Frame Size 42 mm Connector Direction Upper Side

Product Name	Gear Ratio	Mass [kg]
<b>AZM46MCH-FC</b> ■ <b>UA</b>	<b>7.2, 10, 20, 30</b>	0.89

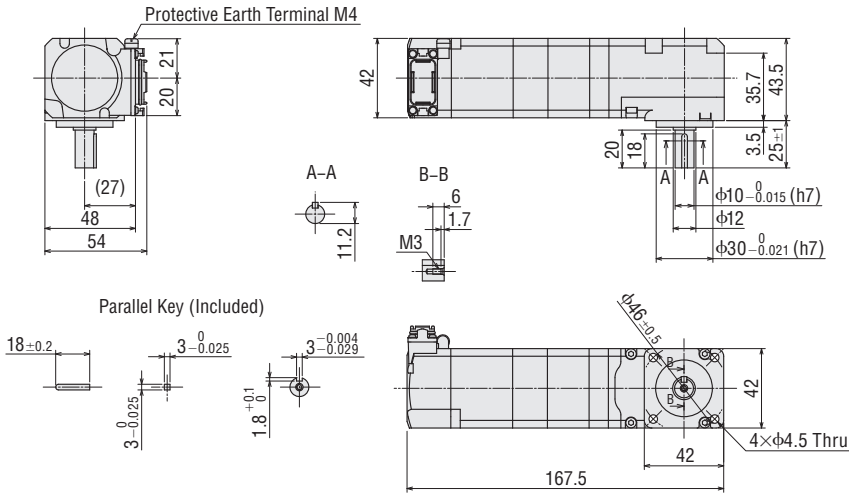

● When the Connection Cable is Attached  
 Cable Outlet in Output Shaft Direction

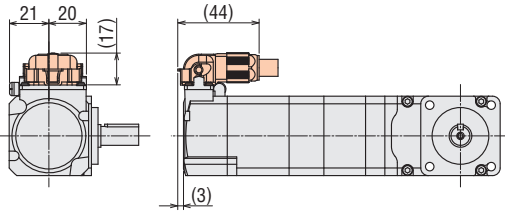

Cable Outlet in Vertical Direction

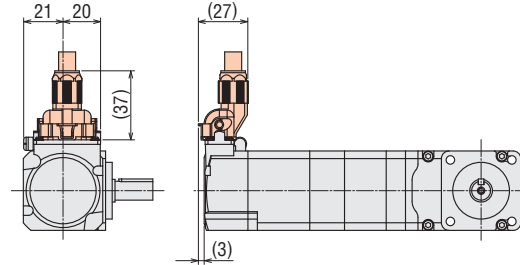

Cable Outlet Opposite to Output Shaft Direction

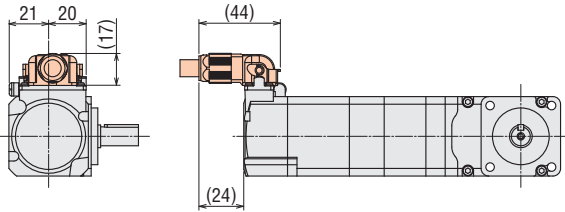

● A number indicating the gear ratio is entered where the box ■ is located within the product name.  
 ● The shaded areas are the separately sold connection cables.

Frame Size 42 mm Connector Direction Down Side

Product Name	Gear Ratio	Mass [kg]
<b>AZM46MCH-FC</b> <span style="border: 1px solid black; padding: 0 2px;"> </span> <b>DA</b>	<b>7.2, 10, 20, 30</b>	0.89

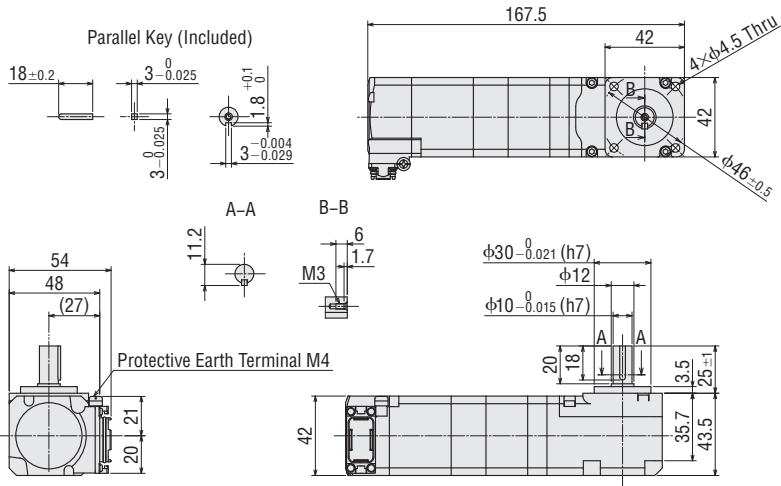

● When the Connection Cable is Attached

Cable Outlet in Output Shaft Direction

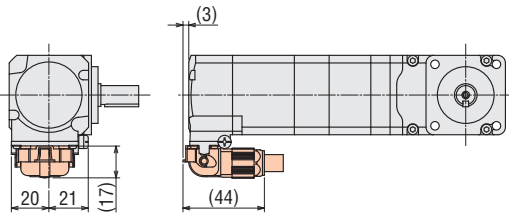

Cable Outlet in Vertical Direction

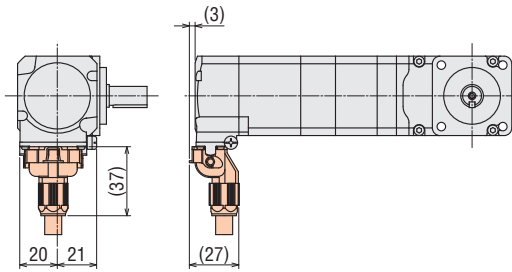

Cable Outlet Opposite to Output Shaft Direction

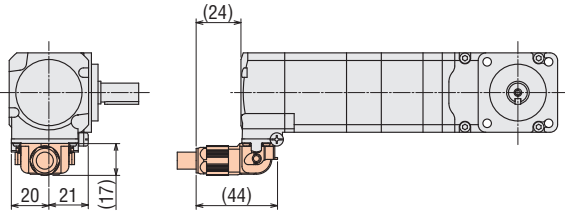

● A number indicating the gear ratio is entered where the box   is located within the product name.  
 ● The shaded  areas are the separately sold connection cables.

### Frame Size 60 mm Connector Direction Upper Side

Product Name	Gear Ratio	Mass [kg]
<b>AZM66MCH-FC</b> <span style="border: 1px solid black; padding: 0 2px;"> </span> <b>UA</b>	<b>7.2, 10, 20, 30</b>	2.1

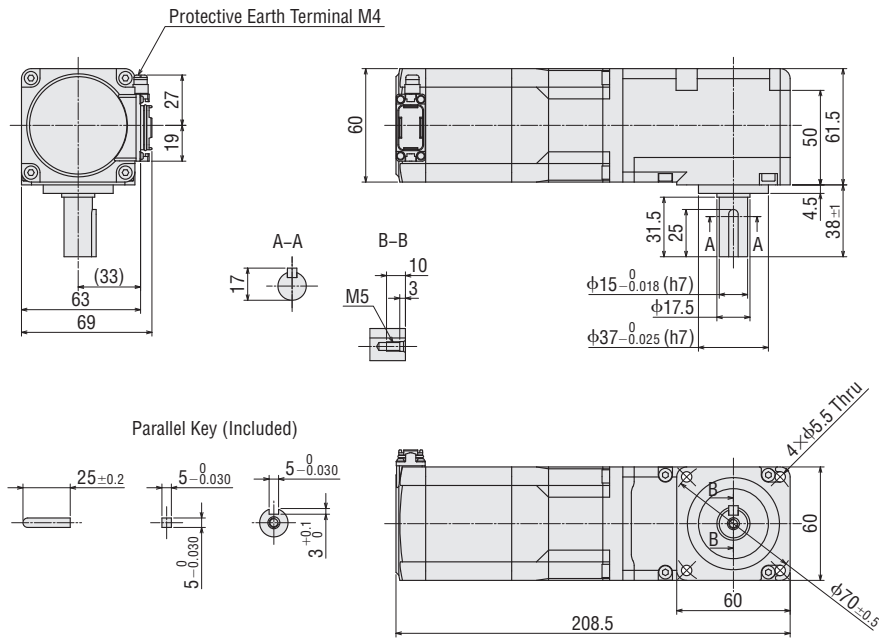

#### ● When the Connection Cable is Attached

Cable Outlet in Output Shaft Direction

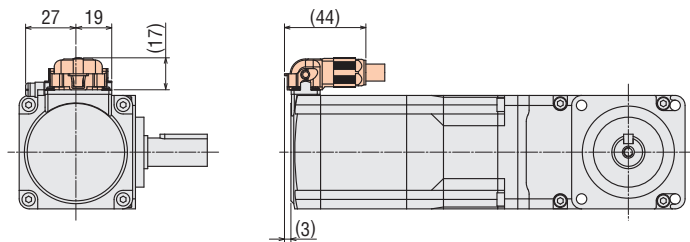

Cable Outlet in Vertical Direction

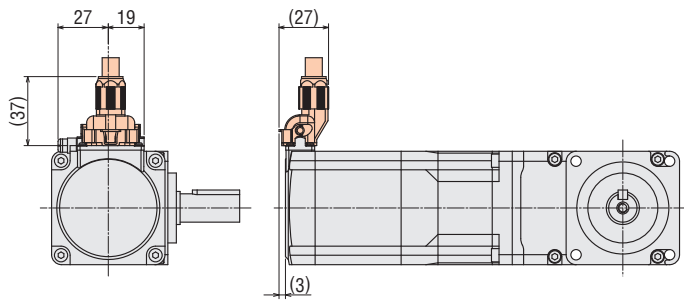

Cable Outlet Opposite to Output Shaft Direction

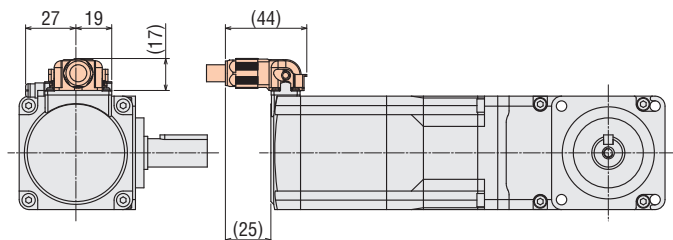

- A number indicating the gear ratio is entered where the box   is located within the product name.
- The shaded  areas are the separately sold connection cables.

System Configuration	Product Line	Specifications and Characteristics	Dimensions	System Configuration	Product Line	Specifications and Characteristics	Dimensions	Cable
AC Input				DC Input				

Frame Size 60 mm Connector Direction Down Side

Product Name	Gear Ratio	Mass [kg]
AZM66MCH-FC <span style="border: 1px solid black; padding: 0 2px;"> </span> DA	7.2, 10, 20, 30	2.1

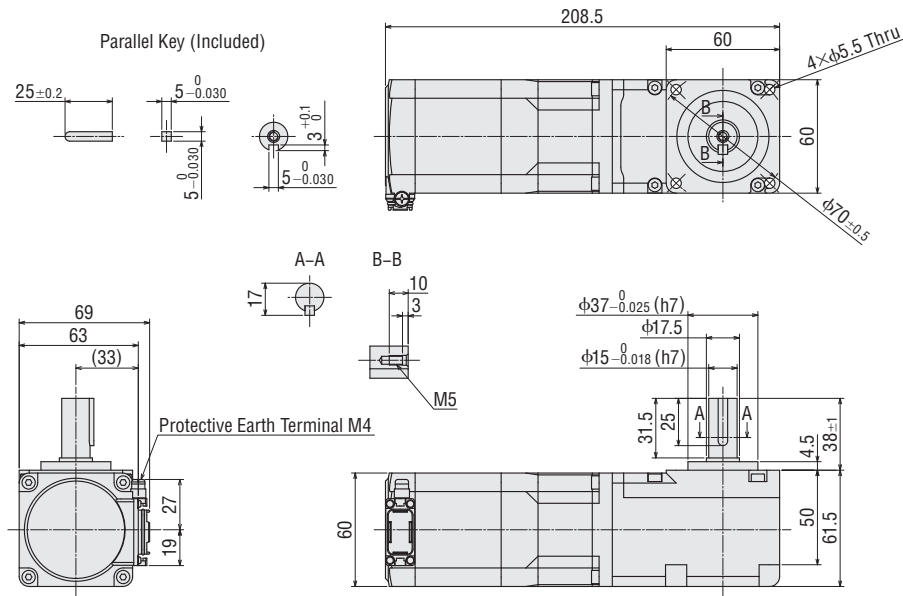

● When the Connection Cable is Attached

Cable Outlet in Output Shaft Direction

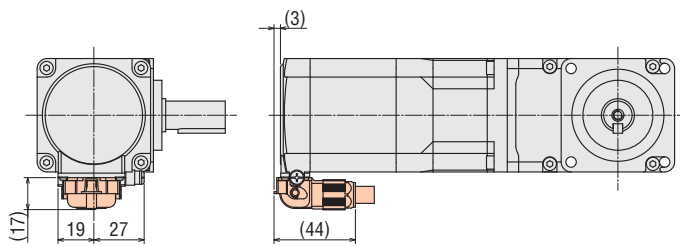

Cable Outlet in Vertical Direction

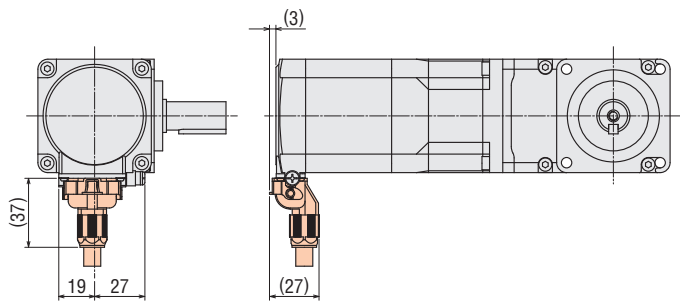

Cable Outlet Opposite to Output Shaft Direction

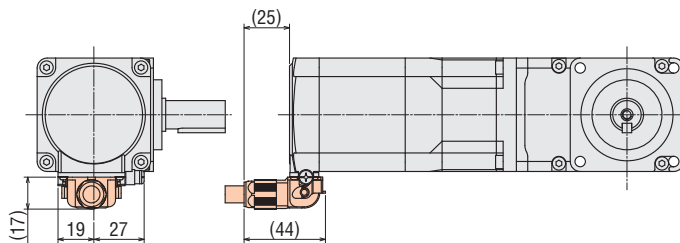

- A number indicating the gear ratio is entered where the box   is located within the product name.
- The shaded  areas are the separately sold connection cables.

◇ **PS Geared Type**  
**Frame Size 42 mm**

Product Name	Gear Ratio	L	Mass [kg]
<b>AZM46ACH-PS</b> <span style="background-color: #cccccc; border: 1px solid black; padding: 0 2px;">  </span>	<b>5, 7.2, 10</b>	103	0.6
	<b>25, 36, 50</b>	126.5	0.75

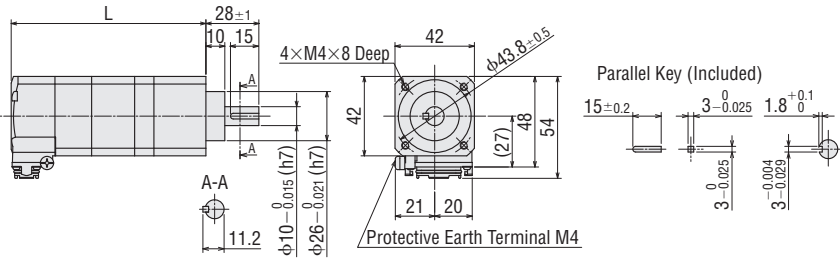

● **When the Connection Cable is Attached**  
**Cable Outlet in Output Shaft Direction**

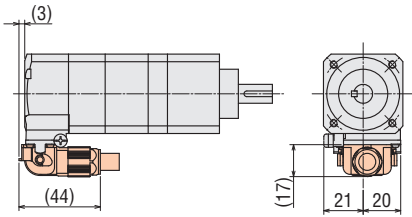

**Cable Outlet in Vertical Direction**

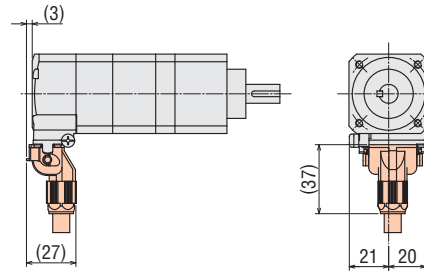

**Cable Outlet Opposite to Output Shaft Direction**

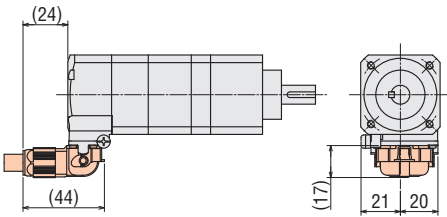

● A number indicating the gear ratio is entered where the box    is located within the product name.  
 ● The shaded    areas are the separately sold connection cables.

Frame Size 60 mm

Product Name	Gear Ratio	L	Mass [kg]
<b>AZM66ACH-PS</b> <span style="background-color: #cccccc; border: 1px solid black; padding: 0 2px;"> </span>	<b>5, 7.2, 10</b>	106.5	1.2
	<b>25, 36, 50</b>	126.5	1.5

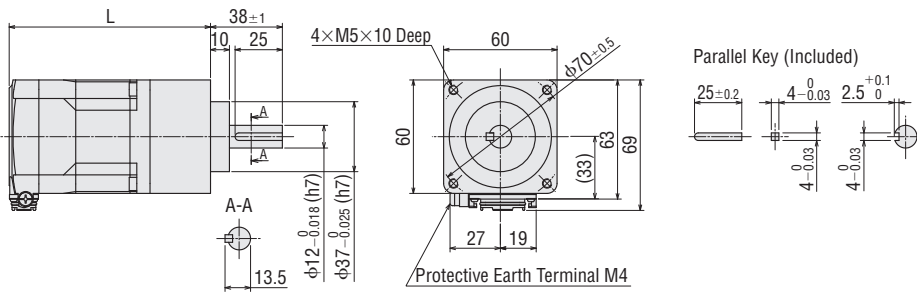

● When the Connection Cable is Attached

Cable Outlet in Output Shaft Direction

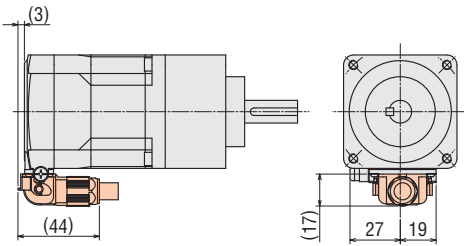

Cable Outlet in Vertical Direction

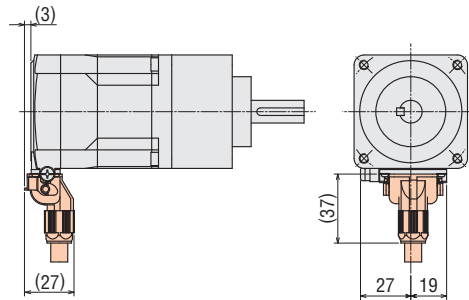

Cable Outlet Opposite to Output Shaft Direction

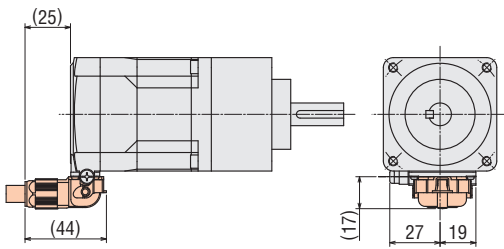

- A number indicating the gear ratio is entered where the box   is located within the product name.
- The shaded   areas are the separately sold connection cables.



◇ **PS Geared Type with Electromagnetic Brake**  
**Frame Size 42 mm**

Product Name	Gear Ratio	L	Mass [kg]
<b>AZM46MCH-PS</b> <span style="background-color: #cccccc; border: 1px solid black; padding: 0 2px;"> </span>	<b>5, 7, 2, 10</b>	134.5	0.74
	<b>25, 36, 50</b>	157.5	0.89

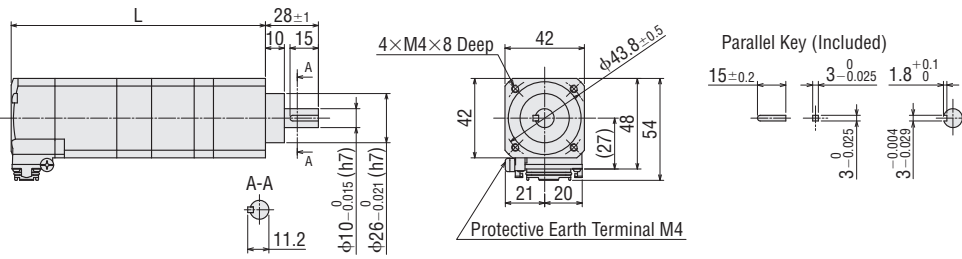

● When the Connection Cable is Attached

Cable Outlet in Output Shaft Direction

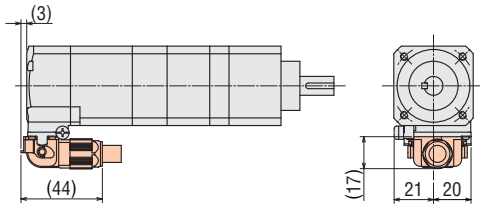

Cable Outlet in Vertical Direction

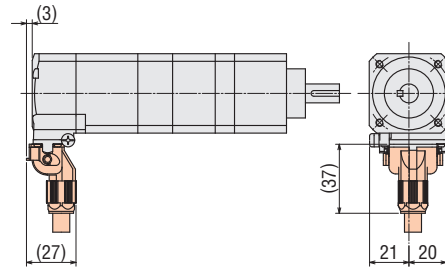

Cable Outlet Opposite to Output Shaft Direction

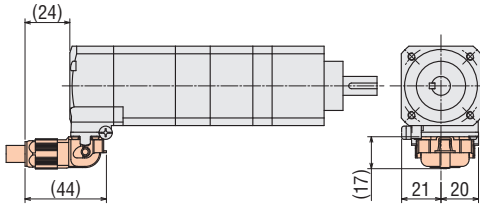

- A number indicating the gear ratio is entered where the box   is located within the product name.
- The shaded   areas are the separately sold connection cables.

Frame Size 60 mm

Product Name	Gear Ratio	L	Mass [kg]
<b>AZM66MCH-PS</b> <span style="background-color: #cccccc; border: 1px solid black; padding: 0 2px;"> </span>	<b>5, 7.2, 10</b>	152	1.6
	<b>25, 36, 50</b>	172	1.9

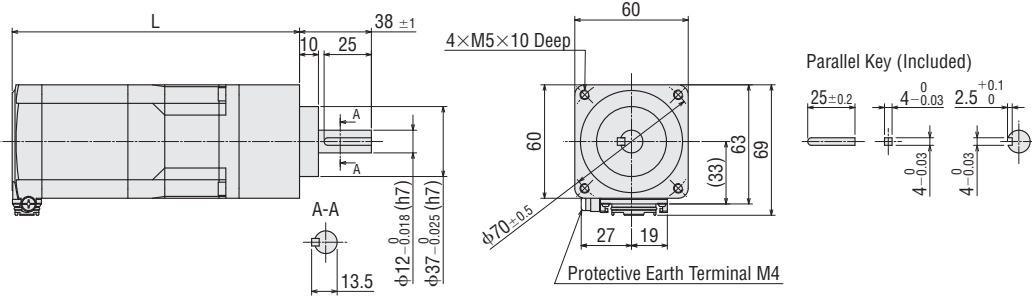

● When the Connection Cable is Attached

Cable Outlet in Output Shaft Direction

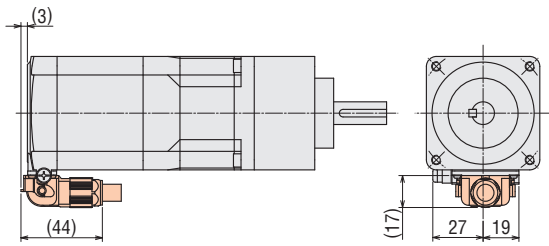

Cable Outlet in Vertical Direction

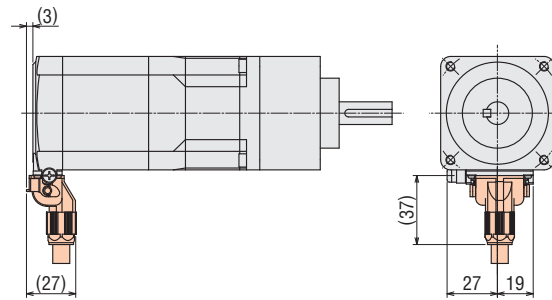

Cable Outlet Opposite to Output Shaft Direction

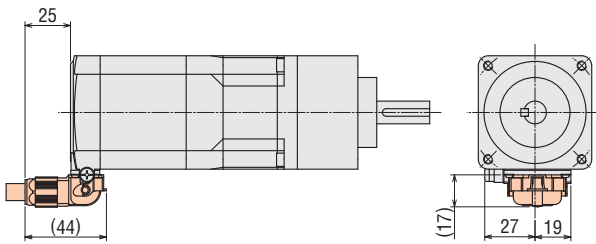

- A number indicating the gear ratio is entered where the box   is located within the product name.
- The shaded   areas are the separately sold connection cables.

◇ Harmonic Geared Type

Frame Size 42 mm

Product Name	Gear Ratio	Mass [kg]
<b>AZM46ACH-HS</b> <span style="border: 1px solid black; padding: 0 2px;"> </span>	<b>50, 100</b>	0.61

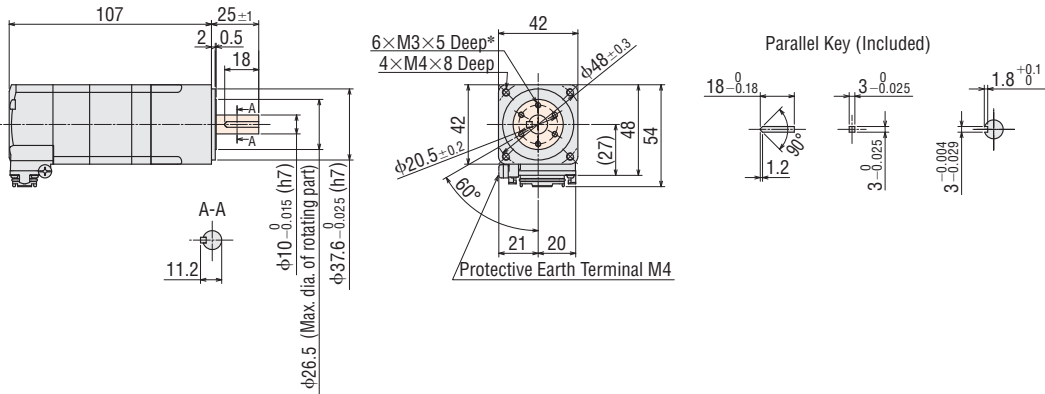

\*The position of the key slot of the output shaft relative to 6×M3 is arbitrary.

● When the Connection Cable is Attached

Cable Outlet in Output Shaft Direction

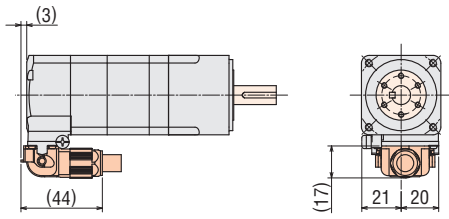

Cable Outlet in Vertical Direction

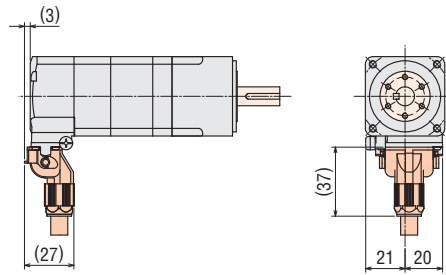

Cable Outlet Opposite to Output Shaft Direction

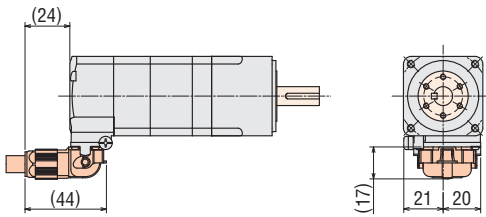

- A number indicating the gear ratio is entered where the box   is located within the product name.
- The shaded  areas in the dimensions are rotating parts.
- The shaded  areas are the separately sold connection cables.

System Configuration

Product Line

Specifications and Characteristics

Dimensions

System Configuration

Product Line

Specifications and Characteristics

Dimensions

Cable

## Frame Size 60 mm

Product Name	Gear Ratio	Mass [kg]
<b>AZM66ACH-HS</b> <span style="background-color: #cccccc; border: 1px solid black; padding: 0 2px;"> </span>	<b>50, 100</b>	1.3

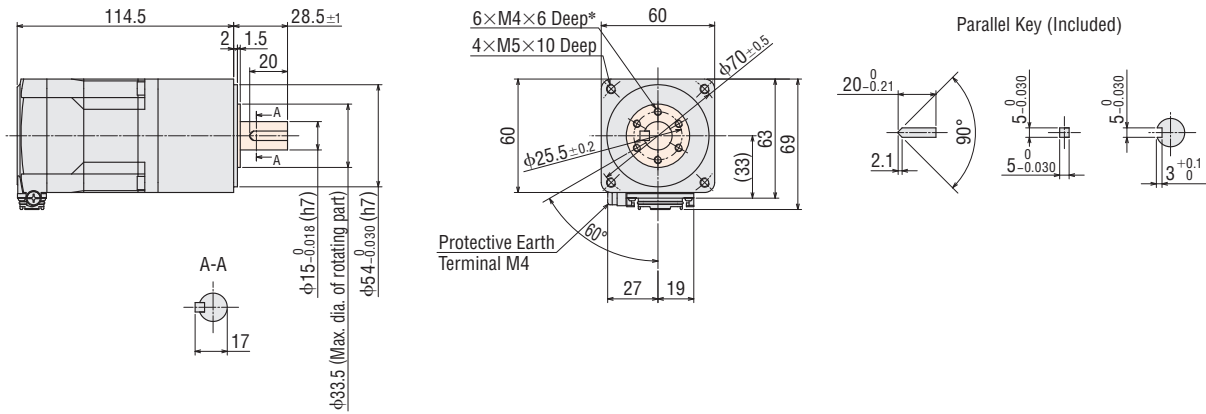

\*The position of the key slot of the output shaft relative to 6 × M4 is arbitrary.

### ● When the Connection Cable is Attached

Cable Outlet in Output Shaft Direction

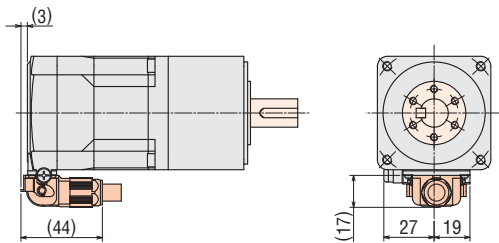

Cable Outlet in Vertical Direction

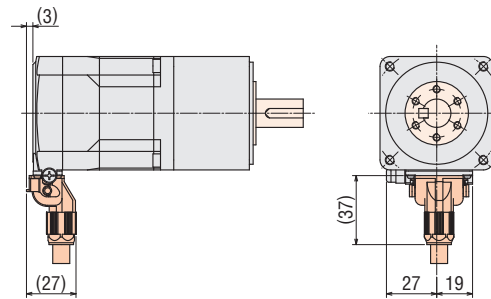

Cable Outlet Opposite to Output Shaft Direction

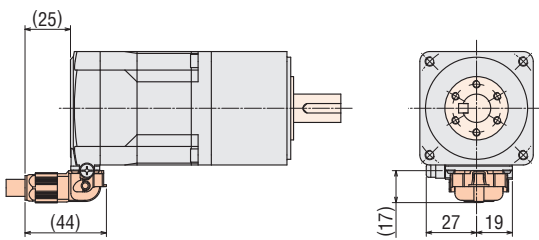

- A number indicating the gear ratio is entered where the box   is located within the product name.
- The shaded   areas in the dimensions are rotating parts.
- The shaded   areas are the separately sold connection cables.

◇ Harmonic Geared Type With Electromagnetic Brake  
Frame Size 42 mm

Product Name	Gear Ratio	Mass [kg]
<b>AZM46MCH-HS</b> <span style="background-color: #cccccc; border: 1px solid black; padding: 0 2px;">  </span>	<b>50, 100</b>	0.75

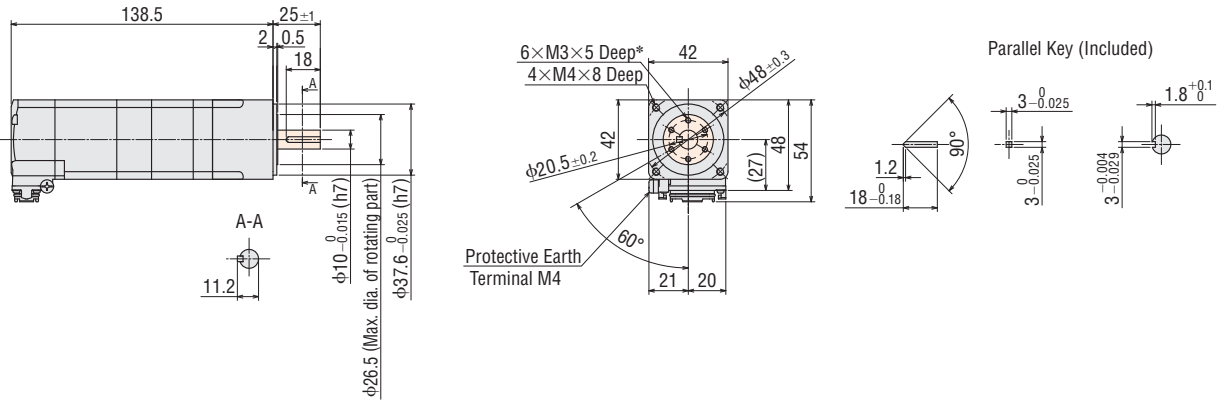

\*The position of the key slot of the output shaft relative to 6×M3 is arbitrary.

● When the Connection Cable is Attached

Cable Outlet in Output Shaft Direction

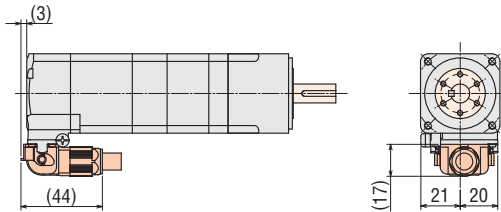

Cable Outlet in Vertical Direction

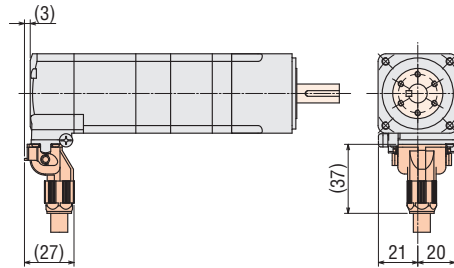

Cable Outlet Opposite to Output Shaft Direction

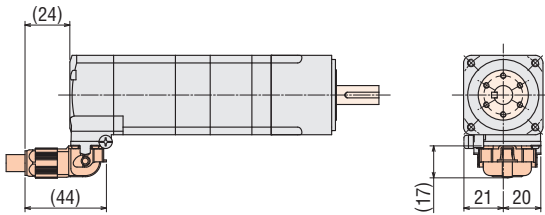

- A number indicating the gear ratio is entered where the box    is located within the product name.
- The shaded  areas in the dimensions are rotating parts.
- The shaded  areas are the separately sold connection cables.

System Configuration

Product Line

AC Input

Specifications and Characteristics

Dimensions

System Configuration

Product Line

DC Input

Specifications and Characteristics

Dimensions

Cable

Frame Size 60 mm

Product Name	Gear Ratio	Mass [kg]
AZM66MCH-HS	50, 100	1.7

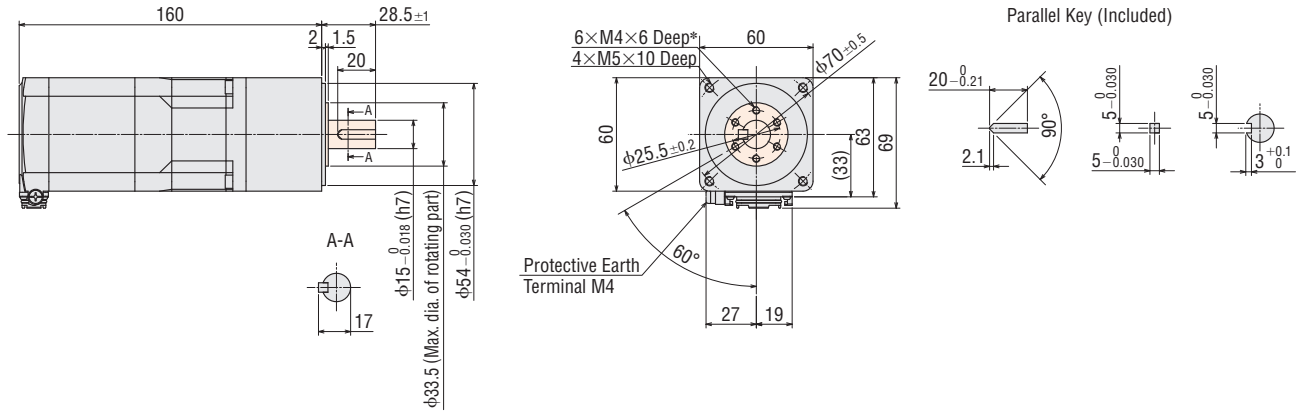

\*The position of the key slot of the output shaft relative to 6×M4 is arbitrary.

● When the Connection Cable is Attached

Cable Outlet in Output Shaft Direction

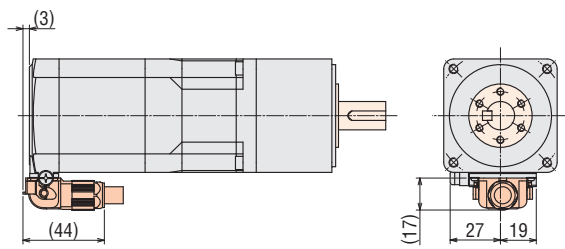

Cable Outlet in Vertical Direction

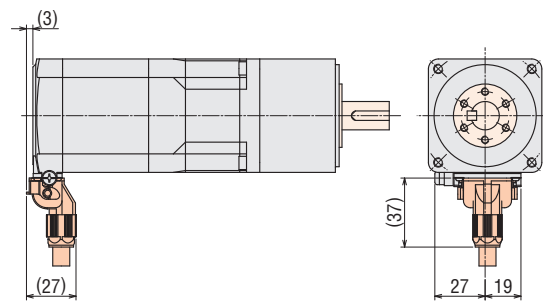

Cable Outlet Opposite to Output Shaft Direction

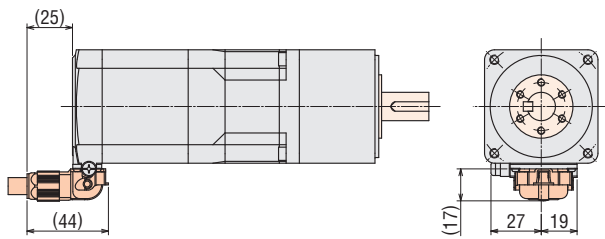

- A number indicating the gear ratio is entered where the box  is located within the product name.
- The shaded  areas in the dimensions are rotating parts.
- The shaded  areas are the separately sold connection cables.

## System Configuration

### Combination of Connector Type Electromagnetic Brake Motor and Network-Compatible Driver

An example of a configuration using I/O control with EtherCAT-compatible driver or EtherCAT is shown below.

Motors, drivers, and connection cables/flexible connection cables must be ordered individually.

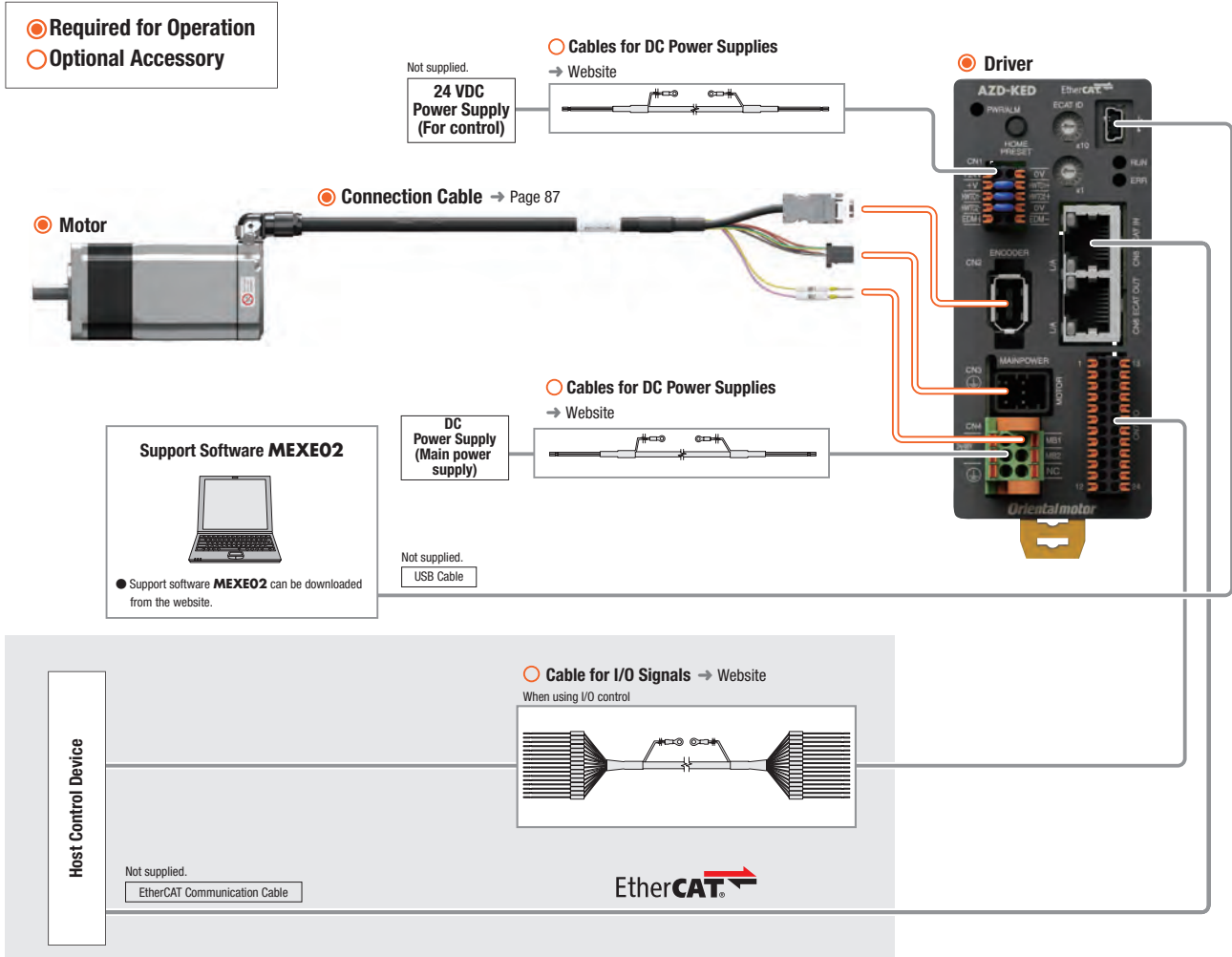

### Example of System Configuration

Motor	+	Driver	+	Cable	
<b>AZM66MKH</b>		<b>AZD-KED</b>		Connection Cable Cable Outlet Direction Output Shaft Side (1 m)	I/O Signal Cable General Purpose Type (1 m)
○		○		<b>CCM010Z1DFF</b>	<b>CC16D010B-1</b>
				○	○

● The system configuration shown above is an example. Other combinations are also available.

● **Combination of Connector Type Electromagnetic Brake Motor and mini Driver Network-Compatible Driver**

An example of a configuration using I/O control with EtherCAT-compatible driver or EtherCAT is shown below.

Motors, drivers, and connection cables/flexible connection cables must be ordered individually.

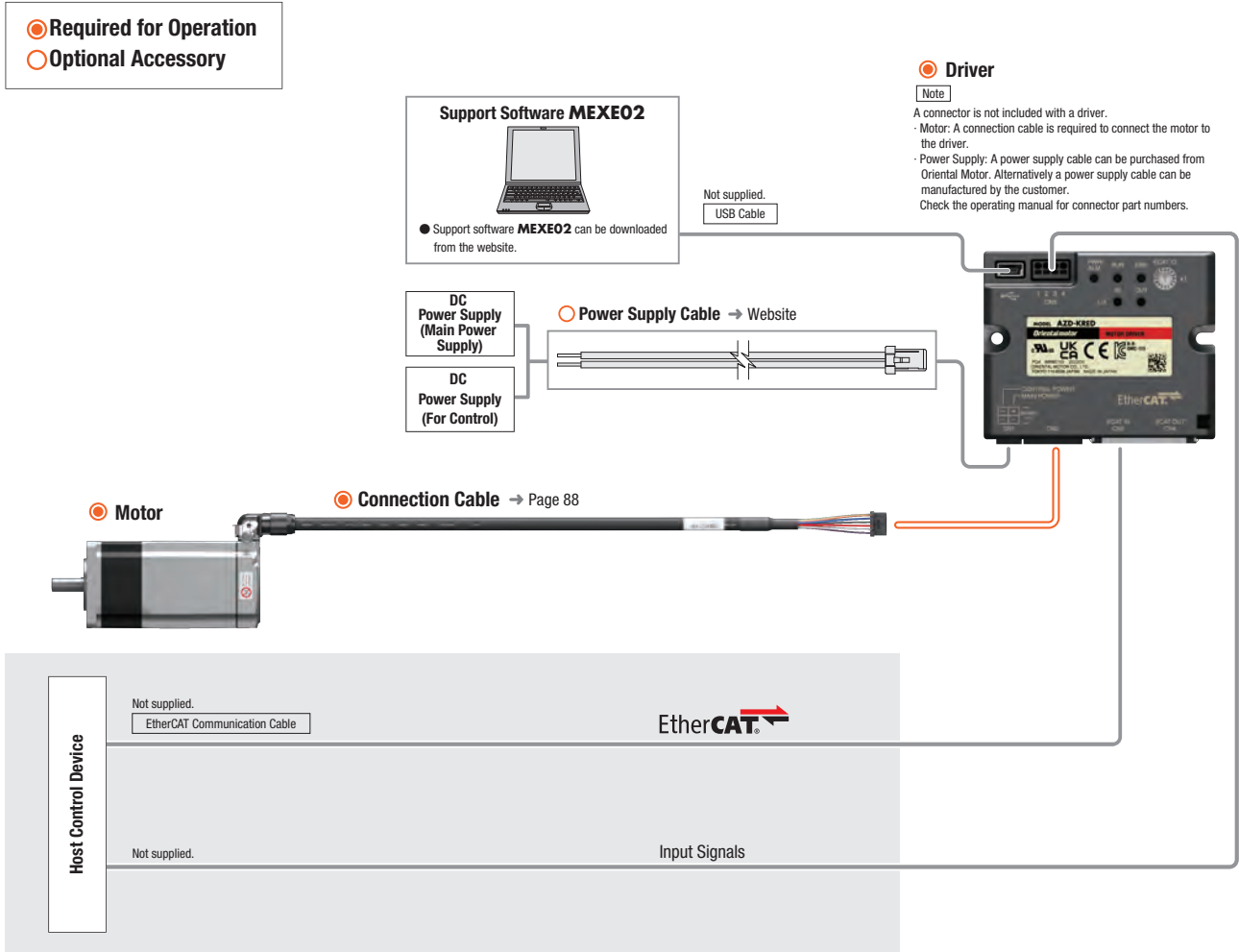

● **Example of System Configuration**



● The system configuration shown above is an example. Other combinations are also available.



## Product Number

### Motor

#### Standard Type

**AZM 6 6 A 0 K H**

① ② ③ ④ ⑤ ⑥ ⑦

#### PS, Harmonic Geared Type

**AZM 6 6 A K H-PS 7.2**

① ② ③ ④ ⑤ ⑥ ⑦ ⑧ ⑨

#### TS Geared Type

**AZM 6 6 A K H - TS 7.2 U**

① ② ③ ④ ⑤ ⑥ ⑦ ⑧ ⑨

#### FC Geared Type

**AZM 6 6 A K H-FC 7.2 U A**

① ② ③ ④ ⑤ ⑥ ⑦ ⑧ ⑨ ⑩

### Connection Cables/Flexible Connection Cables

**CCM 010 Z1 C F F**

① ② ③ ④ ⑤ ⑥

①	Motor Type	<b>AZM: AZ</b> Series Motor
②	Motor Frame Size	<b>4:</b> 42 mm <b>6:</b> 60 mm
③	Motor Case Length	
④	Output Shaft Type	<b>A:</b> Single Shaft <b>M:</b> Type with Electromagnetic Brake
⑤	Additional Function*	<b>0:</b> Round Shaft <b>1:</b> Key Type
⑥	Motor Type	<b>K:</b> DC Input Specification
⑦	Motor Connection Method	<b>H:</b> Connector Type
⑧	Geared Type	<b>PS: PS</b> Geared Type <b>HS:</b> Harmonic Geared Type
⑨	Gear Ratio	

\* If there isn't a number for an additional function, it is a single shaft flat.

①	Motor Type	<b>AZM: AZ</b> Series Motor
②	Motor Frame Size	<b>4:</b> 42 mm <b>6:</b> 60 mm
③	Motor Case Length	
④	Output Shaft Type	<b>A:</b> Single Shaft <b>M:</b> Type with Electromagnetic Brake
⑤	Motor Type	<b>K:</b> DC Input Specification
⑥	Motor Connection Method	<b>H:</b> Connector Type
⑦	Geared Type	<b>TS: TS</b> Geared Type
⑧	Gear Ratio	
⑨	Connector Direction	<b>U:</b> Up <b>L:</b> Left <b>R:</b> Right

①	Motor Type	<b>AZM: AZ</b> Series Motor
②	Motor Frame Size	<b>4:</b> 42 mm <b>6:</b> 60 mm
③	Motor Case Length	
④	Output Shaft Type	<b>A:</b> Single Shaft <b>M:</b> Type with Electromagnetic Brake
⑤	Motor Type	<b>K:</b> DC Input Specification
⑥	Motor Connection Method	<b>H:</b> Connector Type
⑦	Geared Type	<b>FC: FC</b> Geared Type
⑧	Gear Ratio	
⑨	Connector Direction*	<b>D:</b> Down <b>U:</b> Up
⑩	Identification	<b>A:</b> Solid Shaft

\*The connector direction is as viewed from the gearhead side with the output shaft facing left.

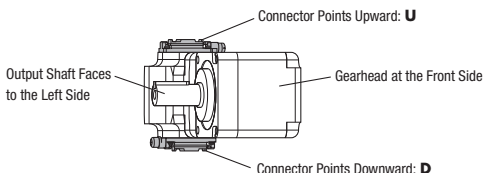

①		<b>CCM:</b> Cable
②	Length	<b>002:</b> 0.2 m, <b>005:</b> 0.5 m, <b>010:</b> 1 m, <b>020:</b> 2 m, <b>030:</b> 3 m, <b>050:</b> 5 m, <b>070:</b> 7 m, <b>100:</b> 10 m
③	Applicable Model	<b>Z1: AZ</b> Series Connector Type
④	Description	<b>C:</b> Single-Axis Driver for DC Input (For motor/encoder) <b>D:</b> Single-Axis Driver for DC Input (For motor/encoder/type with an electromagnetic brake) <b>E:</b> For mini Driver
⑤	Cable Outlet Direction*	<b>F:</b> Output Shaft Direction <b>V:</b> Vertical <b>B:</b> Opposite to Output Shaft Direction
⑥	Cable Type	<b>F:</b> Connection Cable <b>R:</b> Flexible Connection Cable

\*Three types of the connection cables with different cable outlet directions are available. Please select the cable outlet direction needed for the installation.



## Product Line

Motors, drivers, and connection cables must be ordered individually.

### Motor

#### Standard Type



Frame Size	Product Name
42 mm	<b>AZM46AKH</b> <b>AZM46A0KH</b> <b>AZM48AKH</b> <b>AZM48A0KH</b> <b>AZM48A1KH</b>
60 mm	<b>AZM66AKH</b> <b>AZM66A0KH</b> <b>AZM66A1KH</b> <b>AZM69AKH</b> <b>AZM69A0KH</b> <b>AZM69A1KH</b>

#### Standard Type

#### with an Electromagnetic Brake



Frame Size	Product Name
42 mm	<b>AZM46MKH</b> <b>AZM46M0KH</b>
60 mm	<b>AZM66MKH</b> <b>AZM66M0KH</b> <b>AZM66M1KH</b> <b>AZM69MKH</b> <b>AZM69M0KH</b> <b>AZM69M1KH</b>

#### TS Geared Type



Frame Size	Product Name
42 mm	<b>AZM46AKH-TS3.6</b> <b>AZM46AKH-TS3.6R</b> <b>AZM46AKH-TS3.6U</b> <b>AZM46AKH-TS3.6L</b> <b>AZM46AKH-TS7.2</b> <b>AZM46AKH-TS7.2R</b> <b>AZM46AKH-TS7.2U</b> <b>AZM46AKH-TS7.2L</b> <b>AZM46AKH-TS10</b> <b>AZM46AKH-TS10R</b> <b>AZM46AKH-TS10U</b> <b>AZM46AKH-TS10L</b> <b>AZM46AKH-TS20</b> <b>AZM46AKH-TS20R</b> <b>AZM46AKH-TS20U</b> <b>AZM46AKH-TS20L</b> <b>AZM46AKH-TS30</b> <b>AZM46AKH-TS30R</b> <b>AZM46AKH-TS30U</b> <b>AZM46AKH-TS30L</b>
60 mm	<b>AZM66AKH-TS3.6</b> <b>AZM66AKH-TS3.6R</b> <b>AZM66AKH-TS3.6U</b> <b>AZM66AKH-TS3.6L</b> <b>AZM66AKH-TS7.2</b> <b>AZM66AKH-TS7.2R</b> <b>AZM66AKH-TS7.2U</b> <b>AZM66AKH-TS7.2L</b> <b>AZM66AKH-TS10</b> <b>AZM66AKH-TS10R</b> <b>AZM66AKH-TS10U</b> <b>AZM66AKH-TS10L</b> <b>AZM66AKH-TS20</b> <b>AZM66AKH-TS20R</b> <b>AZM66AKH-TS20U</b> <b>AZM66AKH-TS20L</b> <b>AZM66AKH-TS30</b> <b>AZM66AKH-TS30R</b> <b>AZM66AKH-TS30U</b> <b>AZM66AKH-TS30L</b>

#### TS Geared Type

#### with Electromagnetic Brake



Frame Size	Product Name
42 mm	<b>AZM46MKH-TS3.6</b> <b>AZM46MKH-TS3.6R</b> <b>AZM46MKH-TS3.6U</b> <b>AZM46MKH-TS3.6L</b> <b>AZM46MKH-TS7.2</b> <b>AZM46MKH-TS7.2R</b> <b>AZM46MKH-TS7.2U</b> <b>AZM46MKH-TS7.2L</b> <b>AZM46MKH-TS10</b> <b>AZM46MKH-TS10R</b> <b>AZM46MKH-TS10U</b> <b>AZM46MKH-TS10L</b> <b>AZM46MKH-TS20</b> <b>AZM46MKH-TS20R</b> <b>AZM46MKH-TS20U</b> <b>AZM46MKH-TS20L</b> <b>AZM46MKH-TS30</b> <b>AZM46MKH-TS30R</b> <b>AZM46MKH-TS30U</b> <b>AZM46MKH-TS30L</b>
60 mm	<b>AZM66MKH-TS3.6</b> <b>AZM66MKH-TS3.6R</b> <b>AZM66MKH-TS3.6U</b> <b>AZM66MKH-TS3.6L</b> <b>AZM66MKH-TS7.2</b> <b>AZM66MKH-TS7.2R</b> <b>AZM66MKH-TS7.2U</b> <b>AZM66MKH-TS7.2L</b> <b>AZM66MKH-TS10</b> <b>AZM66MKH-TS10R</b> <b>AZM66MKH-TS10U</b> <b>AZM66MKH-TS10L</b> <b>AZM66MKH-TS20</b> <b>AZM66MKH-TS20R</b> <b>AZM66MKH-TS20U</b> <b>AZM66MKH-TS20L</b> <b>AZM66MKH-TS30</b> <b>AZM66MKH-TS30R</b> <b>AZM66MKH-TS30U</b> <b>AZM66MKH-TS30L</b>



### ◇FC Geared Type

Frame Size	Product Name
42 mm	<b>AZM46AKH-FC7.2UA</b> <b>AZM46AKH-FC7.2DA</b> <b>AZM46AKH-FC10UA</b> <b>AZM46AKH-FC10DA</b> <b>AZM46AKH-FC20UA</b> <b>AZM46AKH-FC20DA</b> <b>AZM46AKH-FC30UA</b> <b>AZM46AKH-FC30DA</b>
60 mm	<b>AZM66AKH-FC7.2UA</b> <b>AZM66AKH-FC7.2DA</b> <b>AZM66AKH-FC10UA</b> <b>AZM66AKH-FC10DA</b> <b>AZM66AKH-FC20UA</b> <b>AZM66AKH-FC20DA</b> <b>AZM66AKH-FC30UA</b> <b>AZM66AKH-FC30DA</b>



### ◇FC Geared Type with Electromagnetic Brake

Frame Size	Product Name
42 mm	<b>AZM46MKH-FC7.2UA</b> <b>AZM46MKH-FC7.2DA</b> <b>AZM46MKH-FC10UA</b> <b>AZM46MKH-FC10DA</b> <b>AZM46MKH-FC20UA</b> <b>AZM46MKH-FC20DA</b> <b>AZM46MKH-FC30UA</b> <b>AZM46MKH-FC30DA</b>
60 mm	<b>AZM66MKH-FC7.2UA</b> <b>AZM66MKH-FC7.2DA</b> <b>AZM66MKH-FC10UA</b> <b>AZM66MKH-FC10DA</b> <b>AZM66MKH-FC20UA</b> <b>AZM66MKH-FC20DA</b> <b>AZM66MKH-FC30UA</b> <b>AZM66MKH-FC30DA</b>



### ◇PS Geared Type

Frame Size	Product Name
42 mm	<b>AZM46AKH-PS5</b> <b>AZM46AKH-PS7.2</b> <b>AZM46AKH-PS10</b> <b>AZM46AKH-PS25</b> <b>AZM46AKH-PS36</b> <b>AZM46AKH-PS50</b>
60 mm	<b>AZM66AKH-PS5</b> <b>AZM66AKH-PS7.2</b> <b>AZM66AKH-PS10</b> <b>AZM66AKH-PS25</b> <b>AZM66AKH-PS36</b> <b>AZM66AKH-PS50</b>



### ◇PS Geared Type with Electromagnetic Brake

Frame Size	Product Name
42 mm	<b>AZM46MKH-PS5</b> <b>AZM46MKH-PS7.2</b> <b>AZM46MKH-PS10</b> <b>AZM46MKH-PS25</b> <b>AZM46MKH-PS36</b> <b>AZM46MKH-PS50</b>
60 mm	<b>AZM66MKH-PS5</b> <b>AZM66MKH-PS7.2</b> <b>AZM66MKH-PS10</b> <b>AZM66MKH-PS25</b> <b>AZM66MKH-PS36</b> <b>AZM66MKH-PS50</b>



### ◇Harmonic Geared Type

Frame Size	Product Name
42 mm	<b>AZM46AKH-HS50</b> <b>AZM46AKH-HS100</b>
60 mm	<b>AZM66AKH-HS50</b> <b>AZM66AKH-HS100</b>



### ◇Harmonic Geared Type with Electromagnetic Brake

Frame Size	Product Name
42 mm	<b>AZM46MKH-HS50</b> <b>AZM46MKH-HS100</b>
60 mm	<b>AZM66MKH-HS50</b> <b>AZM66MKH-HS100</b>

### ●Connection Cables/Flexible Connection Cables

A connection cable is needed to connect the motor and driver. Please be sure to purchase one.

Use a flexible connection cable in applications where the cable is bent and flexed. Refer to page 87 for details.

### Included Items

Type	Included Items	Parallel Key	Motor Installation Screws
Standard Type	Round Shaft with Flat	-	-
	Straight Type	-	-
	With Key	1 piece	-
TS Geared Type	Frame Size 42 mm	-	-
	Frame Size 60 mm	1 piece	M4×60 P0.7 (4 screws)
FC Geared Type		1 piece	-
PS Geared Type	Frame Size 42 mm, 60 mm	1 piece	-
Harmonic Geared Type	Frame Size 42 mm, 60 mm	1 piece	-

## List of Combinations

Product	Type	Product Name
Motor	Standard Type	<b>AZM46</b> <input type="checkbox"/> KH, <b>AZM48A</b> <input type="checkbox"/> KH <b>AZM66</b> <input type="checkbox"/> KH, <b>AZM69</b> <input type="checkbox"/> KH
	<b>TS</b> Geared Type	<b>AZM46</b> <input type="checkbox"/> KH-TS <input type="checkbox"/> <input type="checkbox"/> <b>AZM66</b> <input type="checkbox"/> KH-TS <input type="checkbox"/> <input type="checkbox"/>
	<b>FC</b> Geared Type	<b>AZM46</b> <input type="checkbox"/> KH-FC <input type="checkbox"/> <input type="checkbox"/> A <b>AZM66</b> <input type="checkbox"/> KH-FC <input type="checkbox"/> <input type="checkbox"/> A
	<b>PS</b> Geared Type	<b>AZM46</b> <input type="checkbox"/> KH-PS <input type="checkbox"/> <b>AZM66</b> <input type="checkbox"/> KH-PS <input type="checkbox"/>
	Harmonic Geared Type	<b>AZM46</b> <input type="checkbox"/> KH-HS <input type="checkbox"/> <b>AZM66</b> <input type="checkbox"/> KH-HS <input type="checkbox"/>

+

Product Line	Type	Product Name
Single-Axis Driver	EtherCAT Drive Profile-Compatible	<b>AZD-KED</b>
	EtherNet/IP-Compatible	<b>AZD-KEP</b>
	PROFINET-compatible	<b>AZD-KPN</b>
	Built-in Controller Type	<b>AZD-KD</b>
	Pulse Input Type with RS-485 Communication	<b>AZD-KX</b>
	Pulse Input Type	<b>AZD-K</b>
mini Driver	EtherCAT Drive Profile-Compatible	<b>AZD-KRED</b>
	EtherNet/IP-Compatible	<b>AZD-KREP</b>
	PROFINET-Compatible	<b>AZD-KRPN</b>
	RS-485 Communication Type	<b>AZD-KR2D</b>
	Pulse Input Type with RS-485 Communication	<b>AZD-KRX</b>

+

Product Line	Type	Product Name
For Single-Axis Driver Connection Cables/Flexible Connection Cables	Connection Cable	For motor/encoder: <b>CCM</b> <input type="checkbox"/> <input type="checkbox"/> <input type="checkbox"/> <input type="checkbox"/> <b>Z1</b> <b>C</b> <b>F</b> For motor/encoder/electromagnetic brake: <b>CCM</b> <input type="checkbox"/> <input type="checkbox"/> <input type="checkbox"/> <input type="checkbox"/> <b>Z1D</b> <b>F</b>
	Flexible Connection Cable	For motor/encoder: <b>CCM</b> <input type="checkbox"/> <input type="checkbox"/> <input type="checkbox"/> <input type="checkbox"/> <b>Z1</b> <b>C</b> <b>R</b> For motor/encoder/electromagnetic brake: <b>CCM</b> <input type="checkbox"/> <input type="checkbox"/> <input type="checkbox"/> <input type="checkbox"/> <b>Z1D</b> <b>R</b>
For mini Driver Connection Cables/Flexible Connection Cables	Connection Cable	For motor/encoder, for motor/encoder/electromagnetic brake: <b>CCM</b> <input type="checkbox"/> <input type="checkbox"/> <input type="checkbox"/> <input type="checkbox"/> <b>Z1</b> <b>E</b> <b>F</b>
	Flexible Connection Cable	For motor/encoder, for motor/encoder/electromagnetic brake: <b>CCM</b> <input type="checkbox"/> <input type="checkbox"/> <input type="checkbox"/> <input type="checkbox"/> <b>Z1</b> <b>E</b> <b>R</b>

● A code or a number indicating either one of the following product lines is entered where the box is located within the product name.

- : Output Shaft Shape
- : Additional Function
- : Gear Ratio
- : Connector Direction
- : Cable Outlet Direction
- : Cable Length

### ● AZ Series Catalog (V-184)

- Driver Functions
- Communication Specifications
- Driver Dimensions
- Cables & Peripheral Equipment



### ● AZ Series mini Driver Catalog (V-209)

- Driver Functions
- Communication Specifications
- Driver Dimensions
- Cables & Peripheral Equipment



● Please see the Oriental Motor website or the catalogs for **AZ Series (V-184)** or **AZ Series mini Driver (V-209)**.

# Standard Type Frame Size 42 mm, 60 mm

## Specifications



Motor Product Name	Single Shaft With Electromagnetic Brake	AZM46A□KH AZM46M□KH	AZM48A□KH -	AZM66A□KH AZM66M□KH	AZM69A□KH AZM69M□KH	
Driver Product Name		AZD-K□, AZD-KR□				
Max. Holding Torque	Nm	0.3	0.72	1	2	
Holding Torque at Motor Standstill	Power ON	Nm	0.15	0.36	0.5	1
	Electromagnetic Brake	Nm	0.15	-	0.5	1
Rotor Inertia	J: kgm <sup>2</sup>	$55 \times 10^{-7}$ ( $71 \times 10^{-7}$ )*1	$115 \times 10^{-7}$	$370 \times 10^{-7}$ ( $530 \times 10^{-7}$ )*1	$740 \times 10^{-7}$ ( $900 \times 10^{-7}$ )*1	
Resolution	Resolution Setting: 1000 P/R	0.36°/Pulse				
Power Supply Input						
Control Power Supply*2		Please check "Driver Specifications" on page 61 for the driver current specifications when combined with a motor.				

● Either a **0** (straight type) or **1** (key type) indicating the additional function is specified where the box □ is located in the product name. (**AZM46** is straight type only) For single shaft flat type motors, there is no number in the □ box.

A letter indicating the driver type is specified where the box ■ is located in the product name. Please check "List of Combinations" on page 52 for driver product names.

● When the motor is operated from 48 VDC input, as a reference, use an inertial load 10 times the rotor inertial ratio or less and twice the safety factor or more when calculating the acceleration torque. (Except for **AZM46**)

\*1 The value inside the ( ) represents the value when an electromagnetic brake motor is connected.

\*2 Except for **AZD-KD**, **AZD-KX**, and **AZD-K**

## Speed – Torque Characteristics (Reference values)

**AZM46**

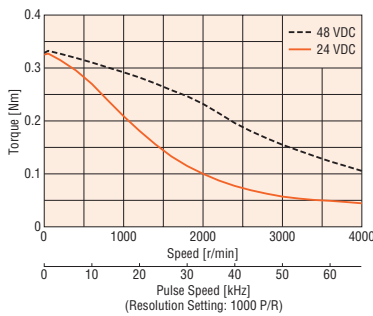

**AZM48**

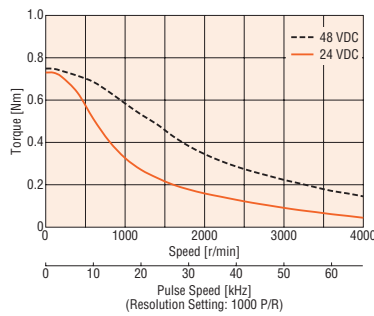

**AZM66**

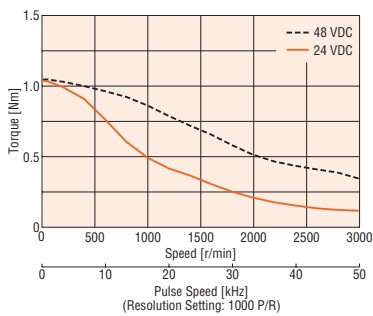

**AZM69**

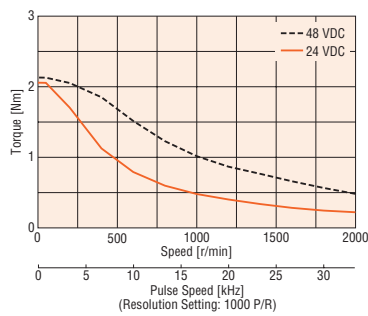

### Note

- Data for the speed – torque characteristics is based on Oriental Motor's internal measurement conditions. If the conditions are changed, the characteristics may also change as a result.
- Depending on the driving conditions, a considerable amount of heat may be generated by the motor. To protect the Absolute Sensor, be sure to keep the temperature of the motor case at 80°C or less. (When conforming to the UL or CSA Standards, the temperature of the motor case must be kept at 75°C or less since the motor is recognized as heat-resistant class A.)

## Explanation of Terminology in Specifications Table

Maximum Holding Torque	:This is the max. holding torque (holding force) the motor has when power is supplied (at rated current) but the motor is not rotating. (With geared types, the value of holding torque considers the permissible strength of the gear.)
Permissible Torque	:This is the maximum value of the torque continuously applied to the output gear shaft.
Maximum Instantaneous Torque	:This is the max. torque that can be applied to the output gear shaft during acceleration/deceleration such when an inertial load is started and stopped.
Holding Torque at Motor Standstill	While Power is ON :Holding torque when the automatic current cutback function is active is shown. Electromagnetic Brake :Static friction torque when the electromagnetic brake is activated at standstill is shown. (Electromagnetic brake is power off activated type.)

# TS Geared Type Frame Size 42 mm



## Specifications

Motor Product Name	Single Shaft	AZM46AKH-TS3.6	AZM46AKH-TS7.2	AZM46AKH-TS10	AZM46AKH-TS20	AZM46AKH-TS30	
	With Electromagnetic Brake	AZM46MKH-TS3.6	AZM46MKH-TS7.2	AZM46MKH-TS10	AZM46MKH-TS20	AZM46MKH-TS30	
Driver Product Name	<b>AZD-K, AZD-KR</b>						
Max. Holding Torque	Nm	0.65	1.2	1.7	2	2.3	
Rotor Inertia	J: kgm <sup>2</sup>	$55 \times 10^{-7}$ ( $71 \times 10^{-7}$ )*1					
Gear Ratio		3.6	7.2	10	20	30	
Resolution	Resolution Setting: 1000 P/R	0.1°/Pulse	0.05°/Pulse	0.036°/Pulse	0.018°/Pulse	0.012°/Pulse	
Permissible Torque	Nm	0.65	1.2	1.7	2	2.3	
Max. Instantaneous Torque*	Nm	0.85	1.6	2	*	3	
Holding Torque at Motor Standstill	Power ON	Nm	0.54	1	1.5	1.8	2.3
	Electromagnetic Brake	Nm	0.54	1	1.5	1.8	2.3
Speed Range	r/min	0~833	0~416	0~300	0~150	0~100	
Backlash	arcmin	45 (0.75)	25 (0.42°)		15 (0.25°)		
Power Supply Input							
Control Power Supply*2	Check "Driver Specifications" on page 61 for the driver current when combined with a motor.						

● Either **R** (Right), **U** (Up), or **L** (Left) indicating the cable outlet direction is specified where the box □ is located in the product name. For down, there is no character in the box □.

A letter indicating the driver type is specified where the box ■ is located in the product name. Check "List of Combinations" on page 52 for driver product names.

\* For the geared motor output torque, refer to the speed-torque characteristics.

\*1 The value inside the ( ) represents the value when connecting an electromagnetic brake motor.

\*2 Excluding **AZD-KD**, **AZD-KX**, and **AZD-K**

## Speed – Torque Characteristics (Reference values)

**AZM46 Gear Ratio 3.6**

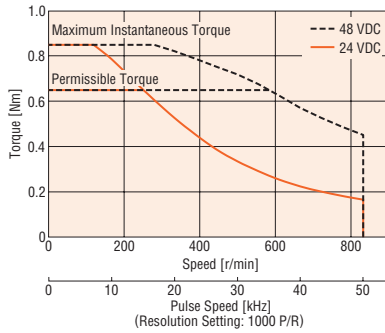

**AZM46 Gear Ratio 7.2**

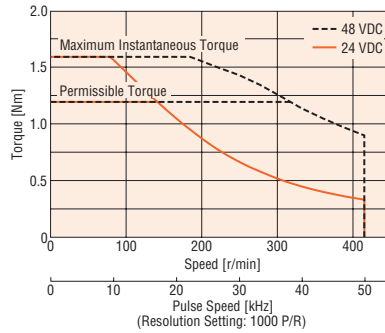

**AZM46 Gear Ratio 10**

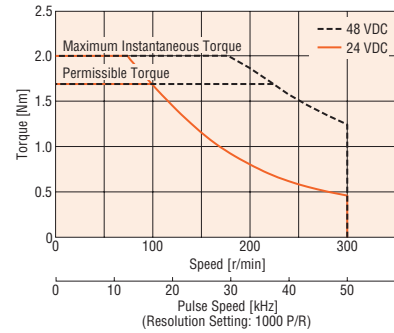

**AZM46 Gear Ratio 20**

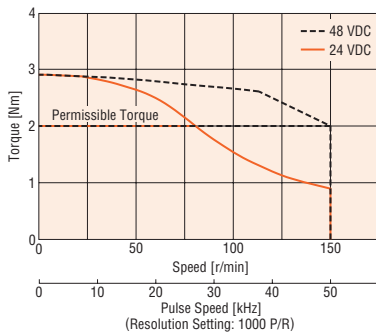

**AZM46 Gear Ratio 30**

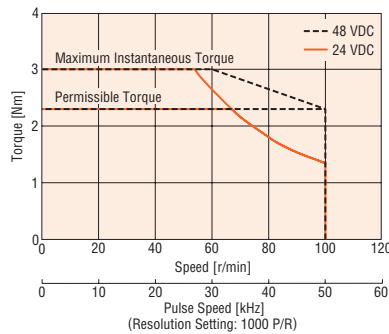

**Note**

● Data for the speed – torque characteristics is based on Oriental Motor's internal measurement conditions. If the conditions are changed, the characteristics may also change as a result.

● Depending on the driving conditions, a considerable amount of heat may be generated by the motor. To protect the absolute sensor, be sure to keep the temperature of the motor case at 80°C or less. (When conforming to the UL or CSA Standards, the temperature of the motor case must be kept at 75°C or less since the motor is recognized as heat-resistant class A.)

# TS Geared Type Frame Size 60 mm

## Specifications



Motor Product Name	Single Shaft	AZM66AKH-TS3.6	AZM66AKH-TS7.2	AZM66AKH-TS10	AZM66AKH-TS20	AZM66AKH-TS30	
Driver Product Name	With Electromagnetic Brake	AZM66MKH-TS3.6	AZM66MKH-TS7.2	AZM66MKH-TS10	AZM66MKH-TS20	AZM66MKH-TS30	
Max. Holding Torque	Nm	1.8	3	4	5	6	
Rotor Inertia	J: kgm <sup>2</sup>	370 × 10 <sup>-7</sup> (530 × 10 <sup>-7</sup> )*1					
Gear Ratio		3.6	7.2	10	20	30	
Resolution	Resolution Setting: 1000 P/R	0.1°/Pulse	0.05°/Pulse	0.036°/Pulse	0.018°/Pulse	0.012°/Pulse	
Permissible Torque	Nm	1.8	3	4	5	6	
Max. Instantaneous Torque*	Nm	*	*	*	8	10	
Holding Torque at Motor Standstill	Power ON	Nm	1.1	2.2	3	5	6
	Electromagnetic Brake	Nm	1.1	2.2	3	5	6
Speed Range	r/min	0~833	0~416	0~300	0~150	0~100	
Backlash	arcmin	35 (0.59°)	15 (0.25°)		10 (0.17°)		
Power Supply Input		Check "Driver Specifications" on page 61 for the driver current when combined with a motor.					
Control Power Supply*2							

- Either **R** (Right), **U** (Up), or **L** (Left) indicating the cable outlet direction is specified where the box  is located in the product name. For down, there is no character in the box .
- A letter indicating the driver type is specified where the box  is located in the product name. Check "List of Combinations" on page 52 for driver product names.
- When the motor is operated from 48 VDC input, as a reference, use an inertial load 10 times the rotor inertial ratio or less and twice the safety factor or more when calculating the acceleration torque.
- \* For the geared motor output torque, refer to the speed-torque characteristics.
- \*1 The value inside the ( ) represents the value when connecting an electromagnetic brake motor.
- \*2 Excluding **AZD-KD**, **AZD-KX**, and **AZD-K**

## Speed – Torque Characteristics (Reference values)

**AZM66 Gear Ratio 3.6**

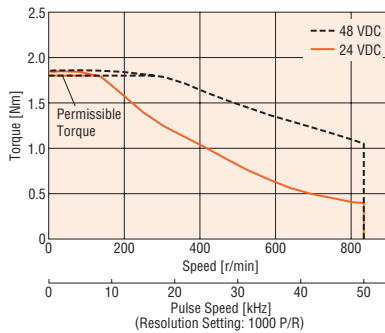

**AZM66 Gear Ratio 7.2**

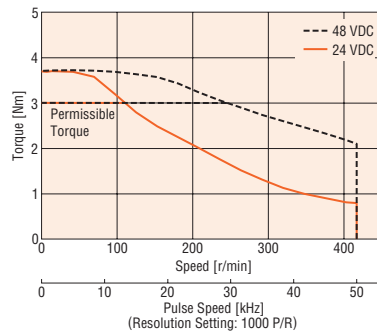

**AZM66 Gear Ratio 10**

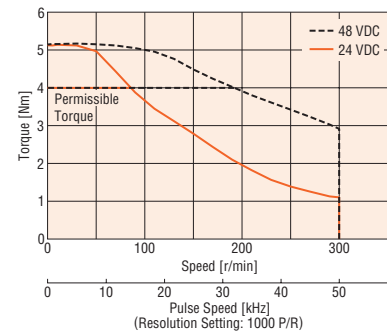

**AZM66 Gear Ratio 20**

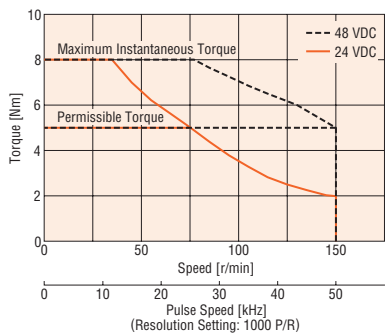

**AZM66 Gear Ratio 30**

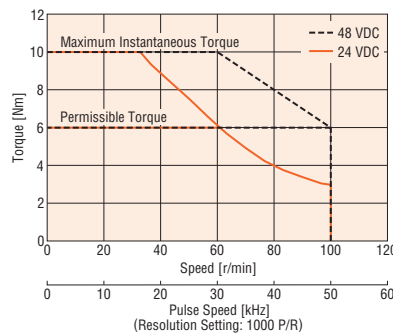

### Note

- Data for the speed – torque characteristics is based on Oriental Motor's internal measurement conditions. If the conditions are changed, the characteristics may also change as a result.
- Depending on the driving conditions, a considerable amount of heat may be generated by the motor. To protect the absolute sensor, be sure to keep the temperature of the motor case at 80°C or less. (When conforming to the UL or CSA Standards, the temperature of the motor case must be kept at 75°C or less since the motor is recognized as heat-resistant class A.)

System Configuration

Product Line

Specifications and Characteristics

Dimensions

System Configuration

Product Line

Specifications and Characteristics

Dimensions

Cable

# FC Geared Type Frame Size 42 mm

## Specifications



Motor Product Name	Single Shaft	<b>AZM46AKH-FC7.2</b> □□A	<b>AZM46AKH-FC10</b> □□A	<b>AZM46AKH-FC20</b> □□A	<b>AZM46AKH-FC30</b> □□A
Driver Product Name	With Electromagnetic Brake	<b>AZM46MKH-FC7.2</b> □□A	<b>AZM46MKH-FC10</b> □□A	<b>AZM46MKH-FC20</b> □□A	<b>AZM46MKH-FC30</b> □□A
Max. Holding Torque	Nm	0.7	1	2	3
Rotor Inertia	J: kgm <sup>2</sup>	$55 \times 10^{-7}$ ( $71 \times 10^{-7}$ )*1			
Gear Ratio		7.2	10	20	30
Resolution	Resolution Setting: 1000 P/R	0.05°/Pulse	0.036°/Pulse	0.018°/Pulse	0.012°/Pulse
Permissible Torque		0.7	1	2	3
Holding Torque at Motor Standstill	Power ON Nm	0.7	1	2	3
	Electromagnetic Brake Nm	0.7	1	2	3
Speed Range	r/min	0~416	0~300	0~150	0~100
Backlash	arcmin	25 (0.42°)		15 (0.25°)	
Power Supply Input		Check "Driver Specifications" on page 61 for the driver current when combined with a motor.			
Control Power Supply*2					

● Either **U** (Up) or **D** (Down) indicating the cable outlet direction is specified where the box □ is located in the product name.  
 A letter indicating the driver type is specified where the box ■ is located in the product name. Check "List of Combinations" on page 52 for driver product names.  
 \*1 The value inside the ( ) represents the value when connecting an electromagnetic brake motor.  
 \*2 Excluding **AZD-KD**, **AZD-KX**, and **AZD-K**

## Speed – Torque Characteristics (Reference values)

**AZM46 Gear Ratio 7.2**

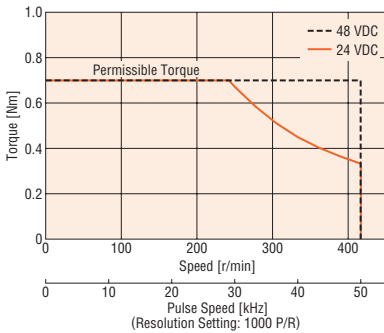

**AZM46 Gear Ratio 10**

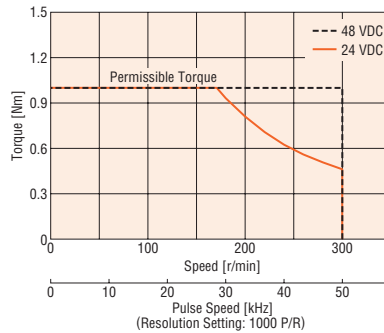

**AZM46 Gear Ratio 20**

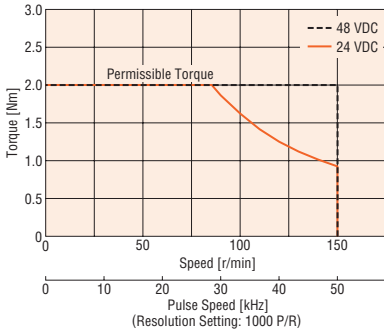

**AZM46 Gear Ratio 30**

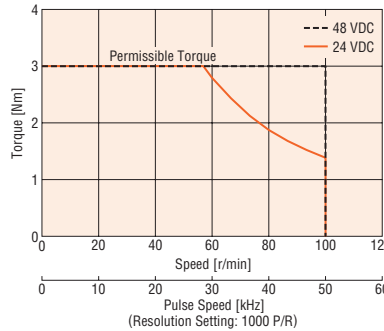

**Note**

- Data for the speed – torque characteristics is based on Oriental Motor's internal measurement conditions. If the conditions are changed, the characteristics may also change as a result.
- Depending on the driving conditions, a considerable amount of heat may be generated by the motor. To protect the absolute sensor, be sure to keep the temperature of the motor case at 80°C or less. (When conforming to the UL or CSA Standards, the temperature of the motor case must be kept at 75°C or less since the motor is recognized as heat-resistant class A.)



# FC Geared Type Frame Size 60 mm

## Specifications



Motor Product Name	Single Shaft	AZM66AKH-FC7.2□A	AZM66AKH-FC10□A	AZM66AKH-FC20□A	AZM66AKH-FC30□A
Driver Product Name	With Electromagnetic Brake	AZM66MKH-FC7.2□A	AZM66MKH-FC10□A	AZM66MKH-FC20□A	AZM66MKH-FC30□A
Max. Holding Torque	Nm	2.5	3.5	7	10.5
Rotor Inertia	J: kgm <sup>2</sup>	370×10 <sup>-7</sup> (530×10 <sup>-7</sup> )*1			
Gear Ratio		7.2	10	20	30
Resolution	Resolution Setting: 1000 P/R	0.05°/Pulse	0.036°/Pulse	0.018°/Pulse	0.012°/Pulse
Permissible Torque		2.5	3.5	7	10.5
Holding Torque at Motor Standstill	Power ON Nm	2.5	3.5	7	10.5
	Electromagnetic Brake Nm	2.5	3.5	7	10.5
Permissible Speed Range	r/min	0~416	0~300	0~150	0~100
Backlash	arcmin	15 (0.25°)		10 (0.17°)	
Power Supply Input		Check "Driver Specifications" on page 61 for the driver current when combined with a motor.			
Control Power Supply*2					

- Either **U** (Up) or **D** (Down) indicating the cable outlet direction is specified where the box □ is located in the product name.
- A letter indicating the driver type is specified where the box ■ is located in the product name. Check "List of Combinations" on page 52 for driver product names.
- When the motor is operated from 48 VDC input, as a reference, use an inertial load 10 times the rotor inertial ratio or less and twice the safety factor or more when calculating the acceleration torque.
- \*1 The value inside the ( ) represents the value when connecting an electromagnetic brake motor.
- \*2 Excluding **AZD-KD**, **AZD-KX**, and **AZD-K**

## Speed – Torque Characteristics (Reference values)

**AZM66 Gear Ratio 7.2**

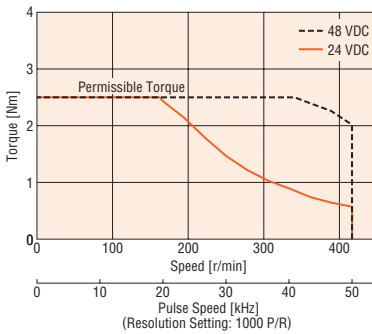

**AZM66 Gear Ratio 10**

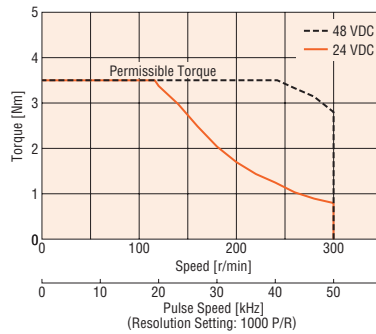

**AZM66 Gear Ratio 20**

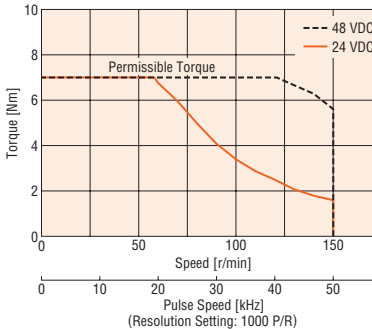

**AZM66 Gear Ratio 30**

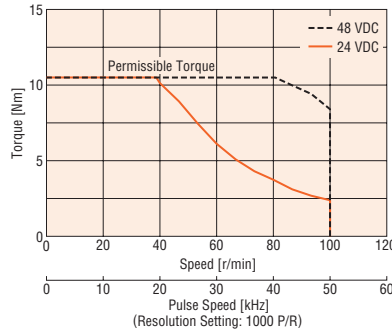

**Note**

- Data for the speed – torque characteristics is based on Oriental Motor's internal measurement conditions. If the conditions are changed, the characteristics may also change as a result.
- Depending on the driving conditions, a considerable amount of heat may be generated by the motor. To protect the absolute sensor, be sure to keep the temperature of the motor case at 80°C or less. (When conforming to the UL or CSA Standards, the temperature of the motor case must be kept at 75°C or less since the motor is recognized as heat-resistant class A.)

System Configuration

Product Line

Specifications and Characteristics

Dimensions

System Configuration

Product Line

DC Input

Specifications and Characteristics

Dimensions

Cable

# PS Geared Type Frame Size 42 mm

## Specifications



Motor Product Name	Single Shaft	AZM46AKH-PS5	AZM46AKH-PS7.2	AZM46AKH-PS10	AZM46AKH-PS25	AZM46AKH-PS36	AZM46AKH-PS50
Driver Product Name	With Electromagnetic Brake	AZM46MKH-PS5	AZM46MKH-PS7.2	AZM46MKH-PS10	AZM46MKH-PS25	AZM46MKH-PS36	AZM46MKH-PS50
		<b>AZD-K, AZD-KR</b>					
Max. Holding Torque	Nm	1	1.5	2.5	3	3	3
Rotor Inertia	J: kgm <sup>2</sup>	$55 \times 10^{-7}$ ( $71 \times 10^{-7}$ )*1					
Gear Ratio		5	7.2	10	25	36	50
Resolution	Resolution Setting: 1000 P/R	0.072°/Pulse	0.05°/Pulse	0.036°/Pulse	0.0144°/Pulse	0.01°/Pulse	0.0072°/Pulse
Permissible Torque	Nm	1	1.5	2.5	3	3	3
Max. Instantaneous Torque*	Nm	*	2	6	*	6	6
Holding Torque at Motor Standstill	Power ON	Nm	0.75	1	1.5	2.5	3
	Electromagnetic Brake	Nm	0.75	1	1.5	2.5	3
Permissible Speed Range	r/min	0~600	0~416	0~300	0~120	0~83	0~60
Backlash	arcmin	15 (0.25°)					
Power Supply Input		Check "Driver Specifications" on page 61 for the driver current when combined with a motor.					
Control Power Supply*2							

● A letter indicating the driver type is specified where the box   is located in the product name. Check "List of Combinations" on page 52 for driver product names.

\* For the geared motor output torque, refer to the speed-torque characteristics.

\*1 The value inside the ( ) represents the value when connecting an electromagnetic brake motor.

\*2 Excluding **AZD-KD**, **AZD-KX**, and **AZD-K**

## Speed – Torque Characteristics (Reference values)

**AZM46 Gear Ratio 5**

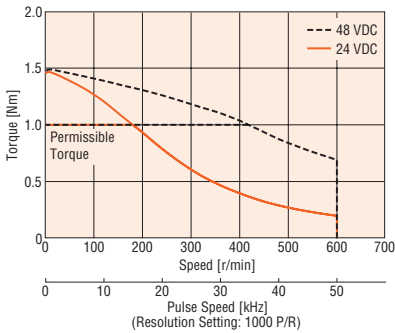

**AZM46 Gear Ratio 7.2**

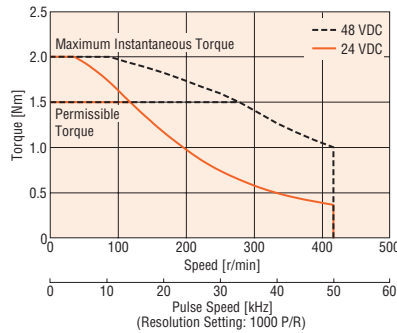

**AZM46 Gear Ratio 10**

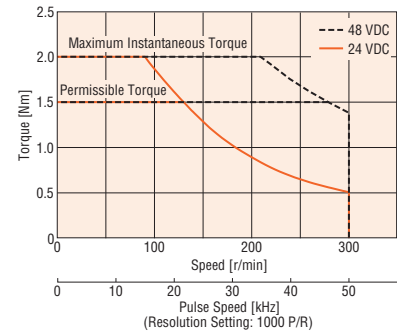

**AZM46 Gear Ratio 25**

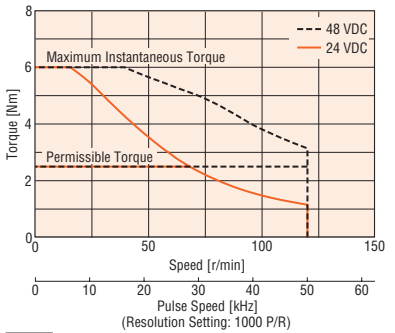

**AZM46 Gear Ratio 36**

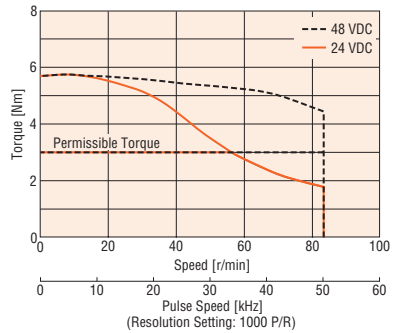

**AZM46 Gear Ratio 50**

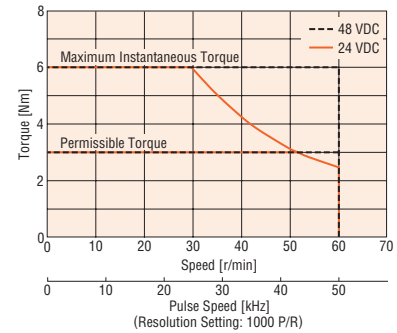

### Note

- Data for the speed – torque characteristics is based on Oriental Motor's internal measurement conditions. If the conditions are changed, the characteristics may also change as a result.
- Depending on the driving conditions, a considerable amount of heat may be generated by the motor. To protect the absolute sensor, be sure to keep the temperature of the motor case at 80°C or less. (When conforming to the UL or CSA Standards, the temperature of the motor case must be kept at 75°C or less since the motor is recognized as heat-resistant class A.)

# PS Geared Type Frame Size 60 mm

## Specifications



Motor Product Name	Single Shaft	AZM66AKH-PS5	AZM66AKH-PS7.2	AZM66AKH-PS10	AZM66AKH-PS25	AZM66AKH-PS36	AZM66AKH-PS50
Driver Product Name	With Electromagnetic Brake	AZM66MKH-PS5	AZM66MKH-PS7.2	AZM66MKH-PS10	AZM66MKH-PS25	AZM66MKH-PS36	AZM66MKH-PS50
Max. Holding Torque	Nm	3.5	4	5	8		
Rotor Inertia	J: kgm <sup>2</sup>	370×10 <sup>-7</sup> (530×10 <sup>-7</sup> )*1					
Gear Ratio		5	7.2	10	25	36	50
Resolution	Resolution Setting: 1000 P/R	0.072°/Pulse	0.05°/Pulse	0.036°/Pulse	0.0144°/Pulse	0.01°/Pulse	0.0072°/Pulse
Permissible Torque	Nm	3.5	4	5	8		
Max. Instantaneous Torque*	Nm	*	*	*	*	*	20
Holding Torque at Motor	Power ON	Nm	2.5	3.6	5	7.6	8
Standstill	Electromagnetic Brake	Nm	2.5	3.6	5	7.6	8
Speed Range	r/min	0~600	0~416	0~300	0~120	0~83	0~60
Backlash	arcmin	7 (0.12°)			9 (0.15°)		
Power Supply Input		Check "Driver Specifications" on page 61 for the driver current when combined with a motor.					
Control Power Supply*2							

- A letter indicating the driver type is specified where the box   is located in the product name. Check "List of Combinations" on page 52 for driver product names.
- When the motor is operated from 48 VDC input, as a reference, use an inertial load 10 times the rotor inertial ratio or less and twice the safety factor or more when calculating the acceleration torque.
- \* For the geared motor output torque, refer to the speed-torque characteristics.
- \*1 The value inside the ( ) represents the value when connecting an electromagnetic brake motor.
- \*2 Excluding AZD-KD, AZD-KX, and AZD-K

## Speed – Torque Characteristics (Reference values)

**AZM66 Gear Ratio 5**

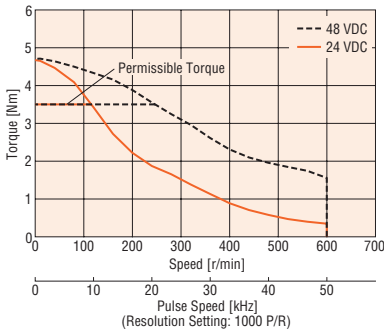

**AZM66 Gear Ratio 7.2**

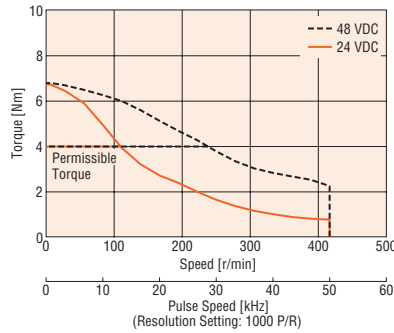

**AZM66 Gear Ratio 10**

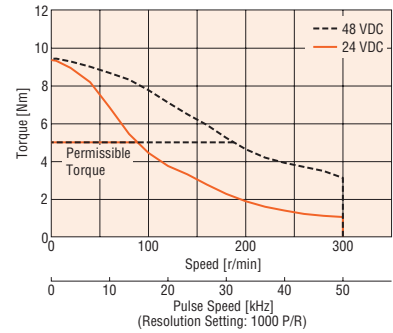

**AZM66 Gear Ratio 25**

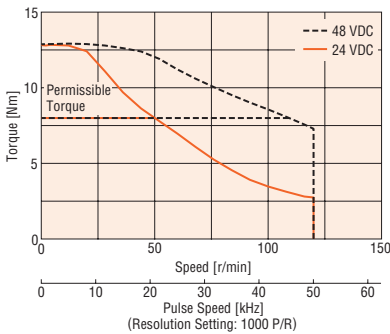

**AZM66 Gear Ratio 36**

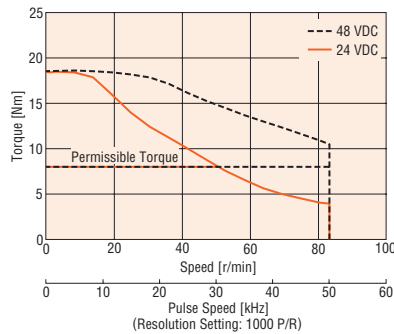

**AZM66 Gear Ratio 50**

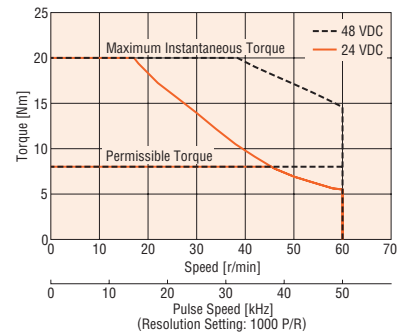

**Note**

- Data for the speed – torque characteristics is based on Oriental Motor's internal measurement conditions. If the conditions are changed, the characteristics may also change as a result.
- Depending on the driving conditions, a considerable amount of heat may be generated by the motor. To protect the absolute sensor, be sure to keep the temperature of the motor case at 80°C or less. (When conforming to the UL or CSA Standards, the temperature of the motor case must be kept at 75°C or less since the motor is recognized as heat-resistant class A.)

System Configuration

Product Line

Specifications and Characteristics

Dimensions

AC Input

System Configuration

Product Line

DC Input

Specifications and Characteristics

Dimensions

Cable

# Harmonic Geared Type Frame Size 42 mm, 60 mm

## Specifications



Motor Product Name	Single Shaft With Electromagnetic Brake	<b>AZM46AKH-HS50</b> <b>AZM46MKH-HS50</b>	<b>AZM46AKH-HS100</b> <b>AZM46MKH-HS100</b>	<b>AZM66AKH-HS50</b> <b>AZM66MKH-HS50</b>	<b>AZM66AKH-HS100</b> <b>AZM66MKH-HS100</b>
Driver Product Name	<b>AZD-K</b> , <b>AZD-KR</b>				
Max. Holding Torque	Nm	3.5	5	7	10
Rotor Inertia	J: kgm <sup>2</sup>	72×10 <sup>-7</sup> (88×10 <sup>-7</sup> )*1		405×10 <sup>-7</sup> (565×10 <sup>-7</sup> )*1	
Gear Ratio		50	100	50	100
Resolution	Resolution Setting: 1000 P/R	0.0072°/Pulse	0.0036°/Pulse	0.0072°/Pulse	0.0036°/Pulse
Permissible Torque	Nm	3.5	5	7	10
Max. Instantaneous Torque*	Nm	8.3	11	*	36
Holding Torque at Power ON	Nm	3.5	5	7	10
Motor Standstill Electromagnetic Brake	Nm	3.5	5	7	10
Permissible Speed Range	r/min	0~70	0~35	0~60	0~30
Lost Motion (Load torque)	arcmin	1.5 max. (±0.16 Nm)	1.5 max. (±0.20 Nm)	0.7 max. (±0.28 Nm)	0.7 max. (±0.39 Nm)
Power Supply Input	Check "Driver Specifications" on page 61 for the driver current when combined with a motor.				
Control Power Supply*2					

● A letter indicating the driver type is specified where the box **■** is located in the product name. Check "List of Combinations" on page 52 for driver product names.  
 ● When the motor is operated from 48 VDC input, as a reference, use an inertial load 10 times the rotor inertia ratio or less and twice the safety factor or more when calculating the acceleration torque (excluding **AZM46**).

\* For the geared motor output torque, refer to the speed-torque characteristics.

\*1 The value inside the ( ) represents the value when connecting an electromagnetic brake motor.

\*2 Excluding **AZD-KD**, **AZD-KX**, and **AZD-K**

### Note

● The rotor inertia represents a sum of the inertia of the harmonic gear converted to motor shaft values.

## Speed – Torque Characteristics (Reference values)

**AZM46 Gear Ratio 50**

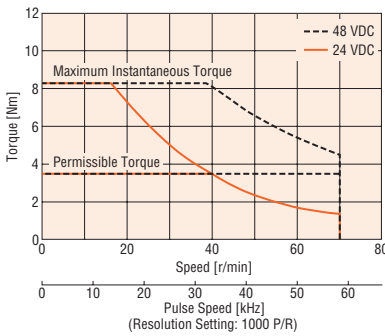

**AZM66 Gear Ratio 50**

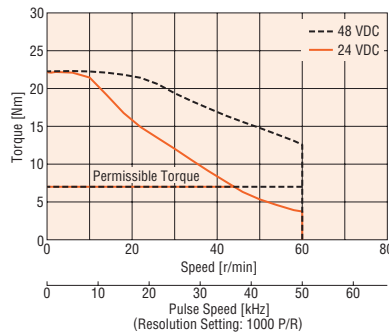

**AZM46 Gear Ratio 100**

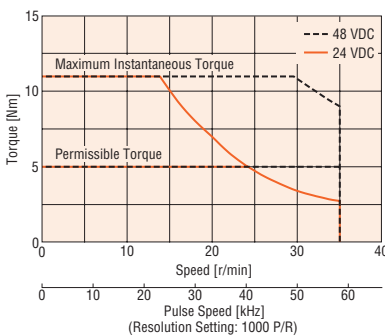

**AZM66 Gear Ratio 100**

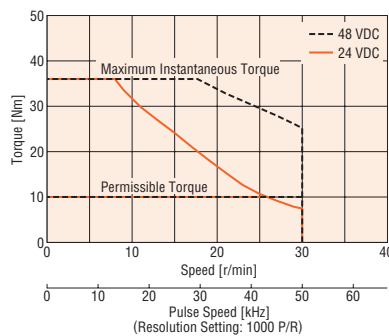

### Note

● Data for the speed – torque characteristics is based on Oriental Motor's internal measurement conditions. If the conditions are changed, the characteristics may also change as a result.

● Depending on the driving conditions, a considerable amount of heat may be generated by the motor. To protect the absolute sensor, be sure to keep the temperature of the motor case at 80°C or less. (When conforming to the UL or CSA Standards, the temperature of the motor case must be kept at 75°C or less since the motor is recognized as heat-resistant class A.)

## Driver Specifications

### Single-Axis Driver

Driver Product Name		AZD-KED AZD-KEP AZD-KPN	AZD-KX AZD-K	AZD-KD
Main Power Supply	Input Voltage	<ul style="list-style-type: none"> <li>• 24 VDC±5%</li> <li>• 48 VDC±5%</li> </ul>		
	Input Current	<b>AZM46</b>	1.5 A	1.72 A (1.8 A)*1
		<b>AZM48</b>	2.1 A	2.2 A
		<b>AZM66</b>	3.3 A	3.55 A (3.8 A)*1
<b>AZM69</b>	3.1 A	3.45 A (3.7 A)*1		
Control Power Supply	Input Voltage	24 VDC±5%		
	Input Current	0.15 A (0.4 A)*2		
Interface	Pulse Input	<ul style="list-style-type: none"> <li>• 2 Points, Photocoupler</li> <li>• Maximum Input Pulse Frequency</li> <li>Line driver: 1 MHz (at 50% duty)</li> <li>Open collector: 250 kHz (at 50% duty)</li> </ul>		—
	Control Input	6 Points, Photocoupler		10 Points, Photocoupler
	Pulse Output	2 Points, Line Driver		
	Control Output	6 Points, Photocoupler and Open-Collector		
	Power Shut Down Signal Input	2 Points, Photocoupler		—
	Power Shut Down Monitor Output	1 Points, Photocoupler/ Open Collector		—

\*1 The value inside the ( ) represents the value when an electromagnetic brake motor is connected.

\*2 The values in parentheses ( ) indicate the specifications when connected to the electromagnetic brake motor. **AZM46** is 0.23 A.

### mini Driver

Driver Product Name		AZD-KRED AZD-KREP AZD-KRPN	AZD-KR2D	AZD-KRX
Main Power Supply	Rated Voltage	<ul style="list-style-type: none"> <li>• 24 VDC±5%</li> <li>• 48 VDC±5%</li> </ul>		
	Input Current*1	<b>AZM46</b> : 1.6 A, <b>AZM48</b> : 2.1 A, <b>AZM66</b> : 3.7 A, <b>AZM69</b> : 3.5 A		
	Permissible Operating Voltage	24 VDC Input: 20 to 32 VDC (22.8 to 32 VDC)*2 48 VDC Input: 40 to 55 VDC		
Control Power Supply	Rated Voltage	<ul style="list-style-type: none"> <li>• 24 VDC±5%</li> <li>• 48 VDC±5%</li> </ul>		
	Input Current	0.15 A (0.4 A)*3		
	Permissible Voltage Range	24 VDC Input: 20 to 32 VDC (22.8 to 32 VDC)*2 48 VDC Input: 40 to 55 VDC		
Interface	Pulse Input	—	—	<ul style="list-style-type: none"> <li>• 2 Points, Photocoupler</li> <li>• Maximum Input Pulse Frequency</li> <li>Line driver: 1 MHz (at 50% duty)</li> <li>Open Collector: 250 kHz (50% duty)</li> </ul>
	Control Input	20 to 32 VDC 2 Points, Photocoupler	—	4.5–32 VDC 5 Points, Photocoupler
	Control Output	—	—	4.5–32 VDC 3 Points, Photocoupler and Open-Collector

\*1 The value of the input current depends on the motor used in combination.

\*2 The values in parentheses ( ) indicate the specifications when connected to the electromagnetic brake motor.

\*3 The value in parentheses ( ) indicates the specification when connected to the electromagnetic brake motor. **AZM46** is 0.23 A.

## General Specifications

		Motor	Driver
Thermal Class		130 (B) [UL/CSA is certified as compliant with 105 (A)]	—
Insulation Resistance		100 MΩ or more when a 500 VDC megger is applied between the following places: • Case–Motor Winding • Case–Electromagnetic Brake Winding*1	100 MΩ or more when a 500 VDC megger is applied between the following places: *2 • Protective Earth Terminal–Power Supply Terminal
Dielectric Strength		Sufficient to withstand the following for 1 minute: • Between the case and motor sensor windings: 1.0 kVAC, 50 Hz or 60 Hz • Between the case and electromagnetic brake windings*1 1.0 kVAC, 50 Hz or 60 Hz	—
Operating Environment (In operation)	Ambient Temperature	0 to +40°C (Non-Freezing)	0 to +50°C (Non-Freezing)
	Ambient Humidity	85% or less (Non-Condensing)	
	Altitude	Max. 1000 m above sea level	
	Atmosphere	No corrosive gases or dust. The product should not be exposed to water, oil or other liquids.	
Degree of Protection		IP66 when a connection cable has been attached (excluding installation surface and the connector on the driver side of the connection cable)	IP10*3
Stop Position Accuracy		<b>AZM46, AZM48:</b> ±4 minutes (±0.067°) <b>AZM66, AZM69:</b> ±3 minutes (±0.05°)	
Shaft Runout		0.05T.I.R. (mm)*4	—
Concentricity of Installation Pilot to the Shaft		0.075T.I.R. (mm)*4	—
Perpendicularity of Installation Surface to the Shaft		0.075T.I.R. (mm)*4	—
Multiple Rotation Detection Range in Power OFF State		±900 Rotation (1800 Rotations)	

\*1 Only for products with an electromagnetic brake

\*2 Excluding mini driver

\*3 IP20 for **AZD-KRED, AZD-KREP, AZD-KRPN, AZD-KRX**

\*4 T. I. R. (Total Indicator Reading): The total dial gauge reading when the measurement section is rotated once around the reference axis center.

### Note

● When measuring insulation resistance or performing dielectric voltage withstand test, disconnect the motor and driver.

Also, do not perform these tests on the ABZO Sensor (Absolute Sensor) part of the motor.

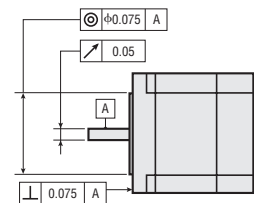

## Electromagnetic Brake Specifications

→ Page 19

## Rotation Direction

→ Page 19

## Permissible Radial Load and Permissible Axial Load

→ Page 20

## Permissible Moment Load

→ Page 21

## Harmonic Geared Type Accuracy

→ Page 22

## Dimensions (Unit: mm)

### ● Motor

#### ◇ Standard Type

Frame Size 42 mm

Shaft Type	Product Name	Mass [kg]
Single Shaft Flat Type	<b>AZM46AKH</b>	0.4
Straight Type	<b>AZM46A0KH</b>	

Single Shaft Flat Type

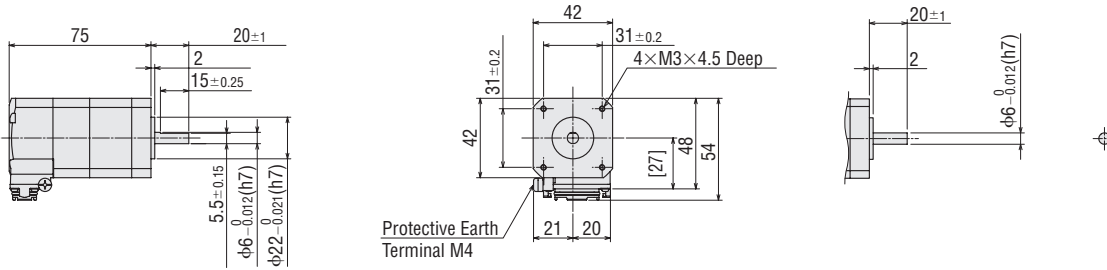

### ● With Connection Cable Attached

Cable Drawn in the Same Direction As the Output Shaft

Cable Drawn Vertically

Cable Drawn in the Opposite Direction of the Output Shaft

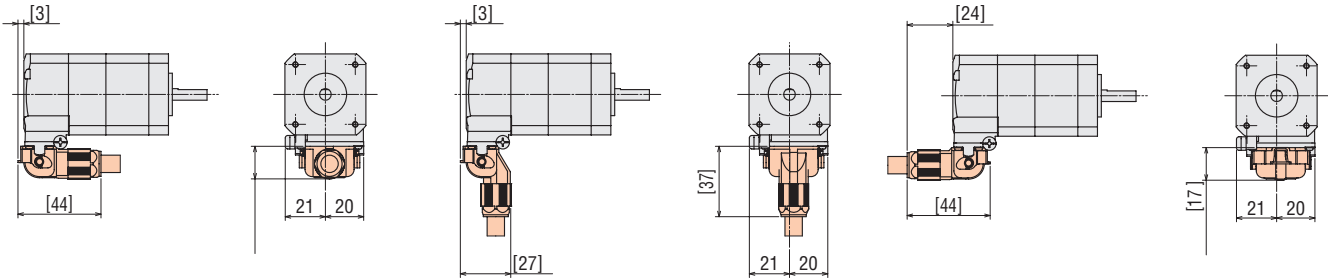

Shaft Type	Product Name	Mass [kg]
Single Shaft Flat Type	<b>AZM48AKH</b>	0.63
Straight Type	<b>AZM48A0KH</b>	
Key Type	<b>AZM48A1KH</b>	

Single Shaft Flat Type

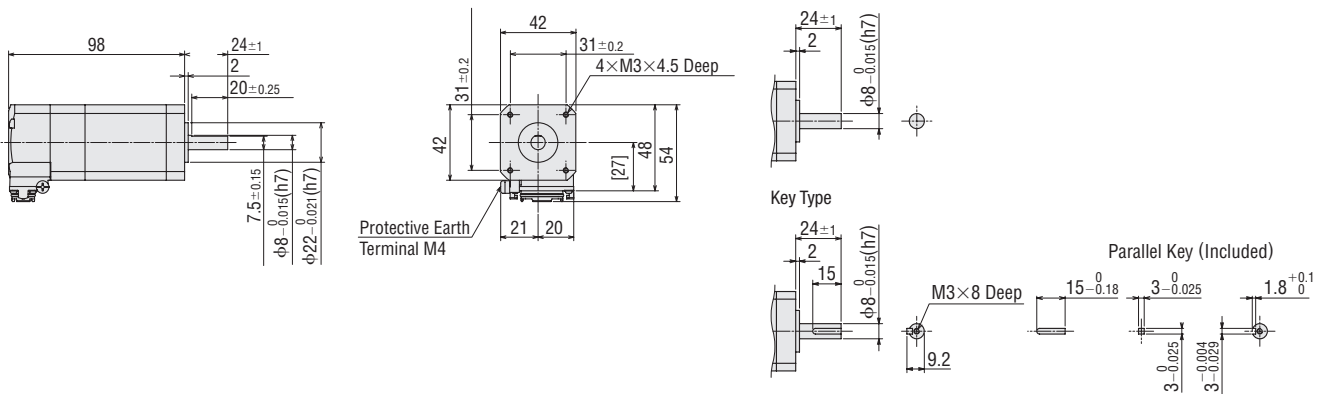

### ● With Connection Cable Attached

Cable Drawn in the Same Direction As the Output Shaft

Cable Drawn Vertically

Cable Drawn in the Opposite Direction of the Output Shaft

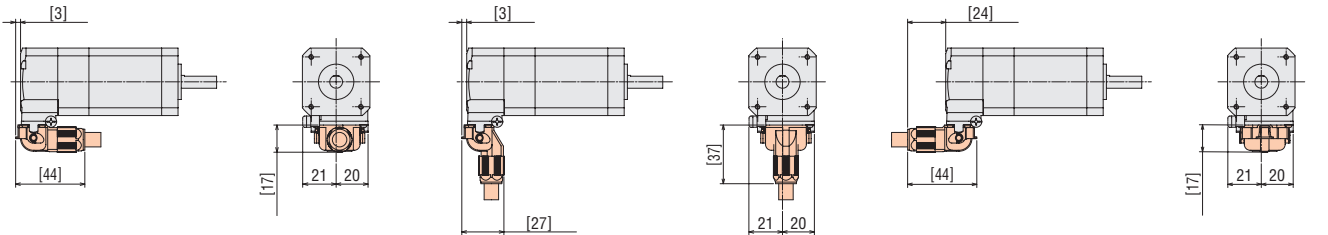

● The color in the dimensions indicates the connection cable that is sold separately.

System Configuration

Product Line

Specifications and Characteristics

Dimensions

System Configuration

Product Line

Specifications and Characteristics

Dimensions

Cable

## Frame Size 60 mm

Shaft Type	Product Name	L	Mass [kg]
Single Shaft Flat Type	<b>AZM66AKH</b>	74.5	0.84
Straight Type	<b>AZM66A0KH</b>		
Key Type	<b>AZM66A1KH</b>		
Single Shaft Flat Type	<b>AZM69AKH</b>	100	1.3
Straight Type	<b>AZM69A0KH</b>		
Key Type	<b>AZM69A1KH</b>		

### Single Shaft Flat Type

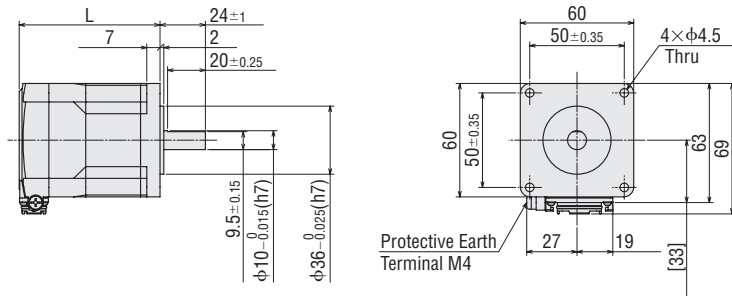

### Straight Type

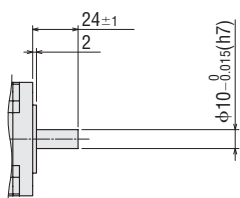

### Key Type

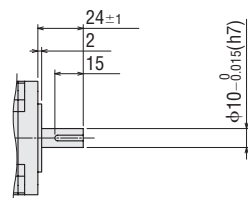

### Parallel Key (Included)

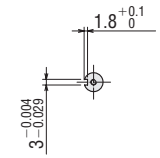
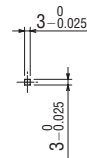
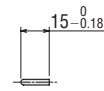
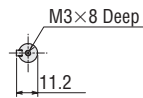

### ● With Connection Cable Attached

#### Cable Drawn in the Same Direction As the Output Shaft

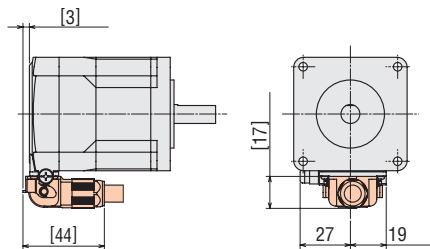

#### Cable Drawn Vertically

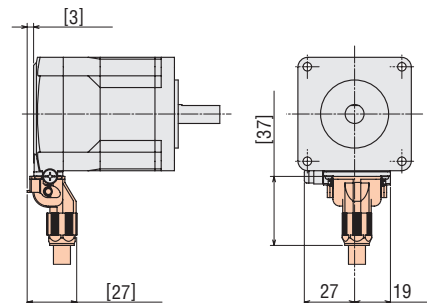

#### Cable Drawn in the Opposite Direction of the Output Shaft

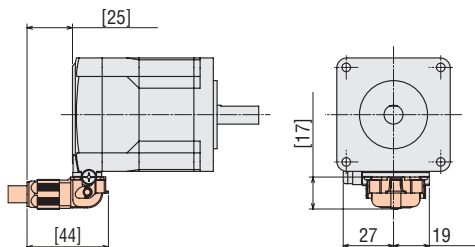

● The color in the dimensions indicates the connection cable that is sold separately.



◇ Standard Type with Electromagnetic Brake  
Frame Size 42 mm

Shaft Type	Product Name	Mass [kg]
Single Shaft Flat Type	<b>AZM46MKH</b>	0.54
Straight Type	<b>AZM46MOKH</b>	

Single Shaft Flat Type

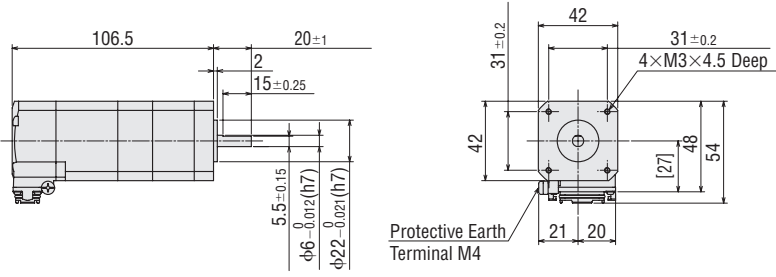

Straight Type

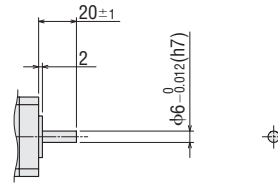

● With Connection Cable Attached

Cable Drawn in the Same Direction As the Output Shaft

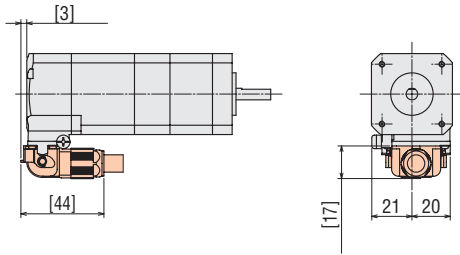

Cable Drawn Vertically

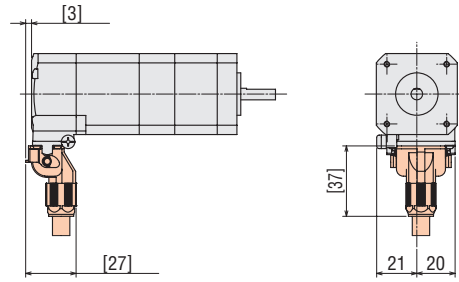

Cable Drawn in the Opposite Direction of the Output Shaft

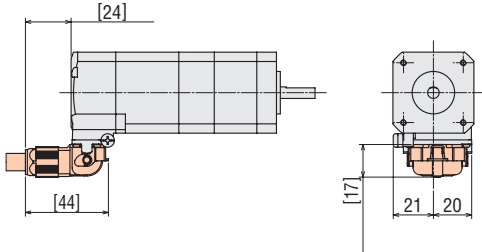

● The color in the dimensions indicates the connection cable that is sold separately.

System Configuration	AC Input	System Configuration
Product Line	Specifications and Characteristics	Product Line
Dimensions	Dimensions	Dimensions
DC Input	System Configuration	System Configuration
Specifications and Characteristics	Product Line	Product Line
Dimensions	Specifications and Characteristics	Specifications and Characteristics
Cable	Dimensions	Dimensions

## Frame Size 60 mm

Shaft Type	Product Name	L	Mass [kg]
Single Shaft Flat Type	<b>AZM66MKH</b>	120	1.2
Straight Type	<b>AZM66M0KH</b>		
Key Type	<b>AZM66M1KH</b>		
Single Shaft Flat Type	<b>AZM69MKH</b>	145.5	1.7
Straight Type	<b>AZM69M0KH</b>		
Key Type	<b>AZM69M1KH</b>		

### Single Shaft Flat Type

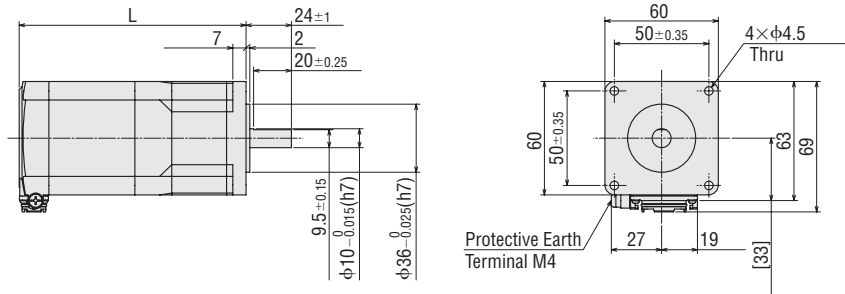

### Straight Type

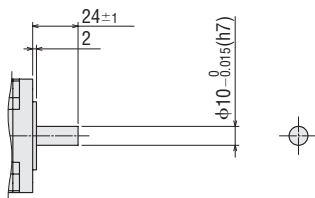

### Key Type

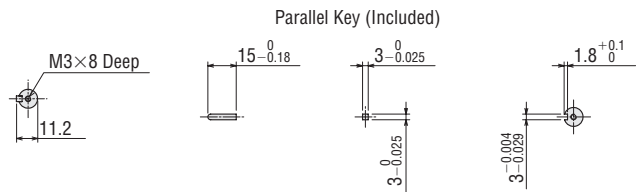
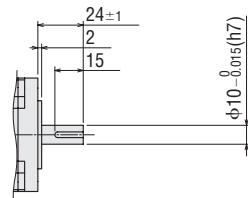

### ● With Connection Cable Attached

Cable Drawn in the Same Direction As the Output Shaft

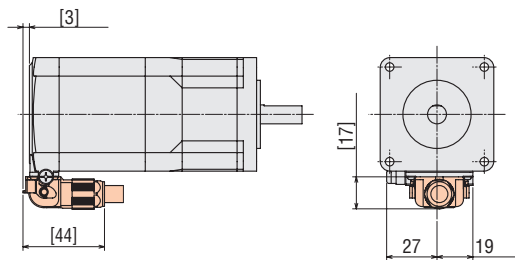

Cable Drawn Vertically

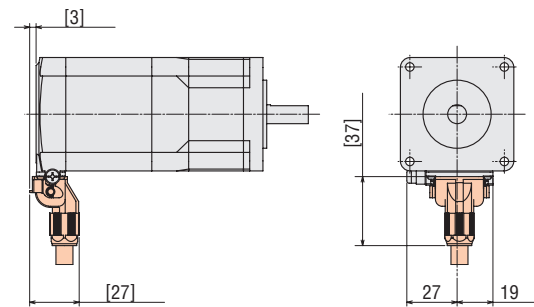

Cable Drawn in the Opposite Direction of the Output Shaft

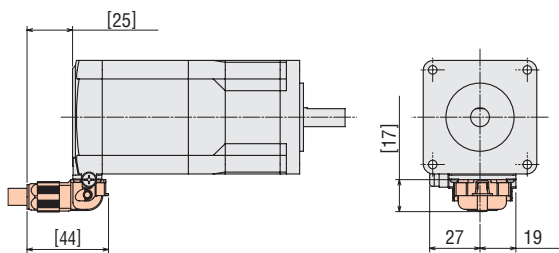

● The color in the dimensions indicates the connection cable that is sold separately.

◇ **TS Geared Type**  
**Frame Size 42 mm**

Connector Direction	Product Name	Gear Ratio	Mass [kg]
Down Side	<b>AZM46AKH-TS</b> <span style="border: 1px solid black; padding: 0 2px;"> </span>	<b>3.6, 7.2, 10, 20, 30</b>	0.55
Right Side	<b>AZM46AKH-TS</b> <b>R</b>		
Upper Side	<b>AZM46AKH-TS</b> <b>U</b>		
Left Side	<b>AZM46AKH-TS</b> <b>L</b>		

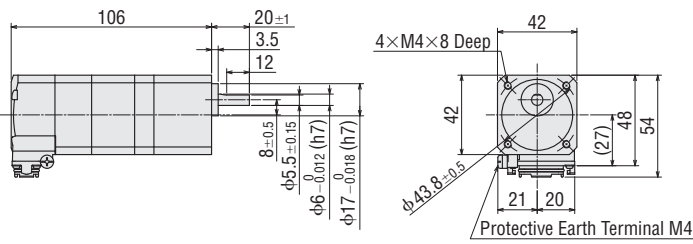

● Connector Direction

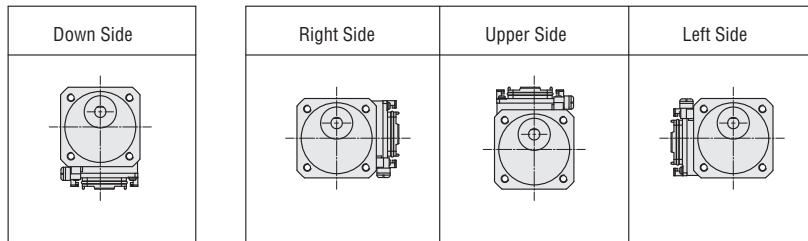

● When the Connection Cable is Attached  
 Cable Outlet in Output Shaft Direction

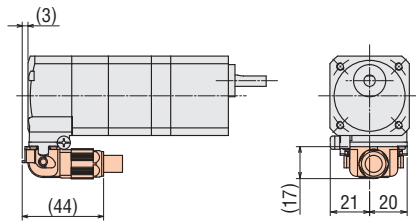

Cable Outlet in Vertical Direction

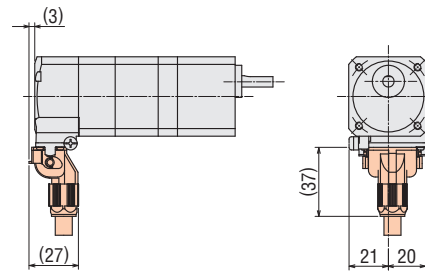

Cable Outlet Opposite to Output Shaft Direction

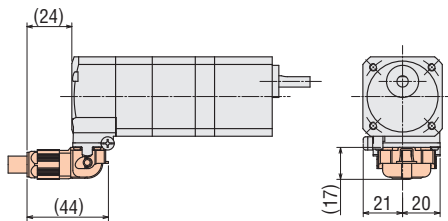

- A number indicating the gear ratio is entered where the box   is located within the product name.
- The shaded  areas are the separately sold connection cables.

## Frame Size 60 mm

Connector Direction	Product Name	Gear Ratio	Mass [kg]
Down Side	<b>AZM66AKH-TS</b> <span style="background-color: #cccccc; border: 1px solid black; padding: 0 2px;"> </span>	<b>3.6, 7.2, 10, 20, 30</b>	1.2
Right Side	<b>AZM66AKH-TS</b> <span style="background-color: #cccccc; border: 1px solid black; padding: 0 2px;">R</span>		
Upper Side	<b>AZM66AKH-TS</b> <span style="background-color: #cccccc; border: 1px solid black; padding: 0 2px;">U</span>		
Left Side	<b>AZM66AKH-TS</b> <span style="background-color: #cccccc; border: 1px solid black; padding: 0 2px;">L</span>		

● Mounting Screws: M4×60 P0.7 (4 pieces included)

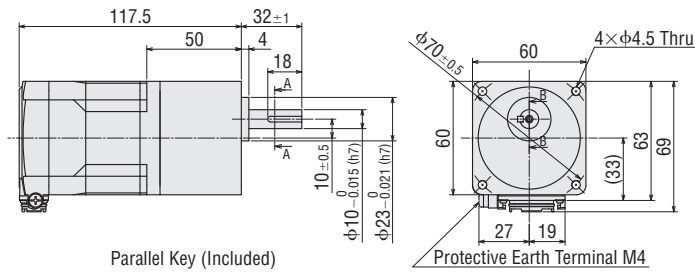

Parallel Key (Included)

Protective Earth Terminal M4

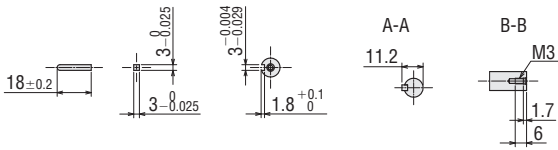

### ● Connector Direction

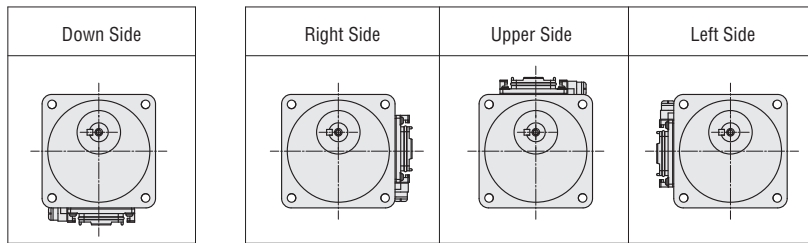

### ● When the Connection Cable is Attached

Cable Outlet in Output Shaft Direction

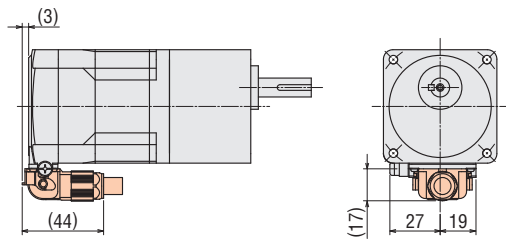

Cable Outlet in Vertical Direction

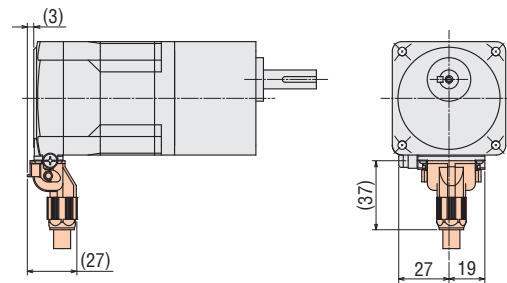

Cable Outlet Opposite to Output Shaft Direction

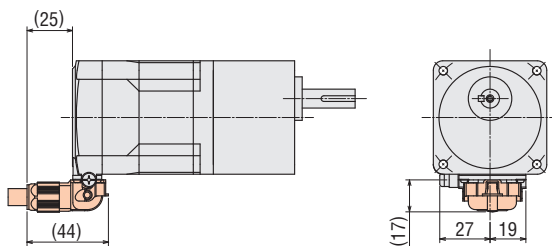

- A number indicating the gear ratio is entered where the box   is located within the product name.
- The shaded   areas are the separately sold connection cables.

◇ **TS Geared Type with Electromagnetic Brake**  
**Frame Size 42 mm**

Connector Direction	Product Name	Gear Ratio	Mass [kg]
Down Side	<b>AZM46MKH-TS</b> <span style="background-color: #cccccc; border: 1px solid black; padding: 0 2px;"> </span>	<b>3.6, 7.2, 10, 20, 30</b>	0.69
Right Side	<b>AZM46MKH-TS</b> <span style="background-color: #cccccc; border: 1px solid black; padding: 0 2px;">R</span>		
Upper Side	<b>AZM46MKH-TS</b> <span style="background-color: #cccccc; border: 1px solid black; padding: 0 2px;">U</span>		
Left Side	<b>AZM46MKH-TS</b> <span style="background-color: #cccccc; border: 1px solid black; padding: 0 2px;">L</span>		

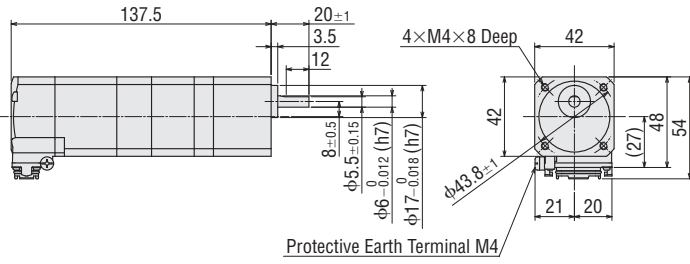

● Connector Direction

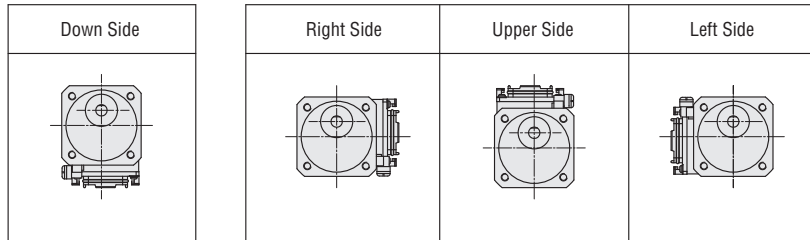

● When the Connection Cable is Attached

Cable Outlet in Output Shaft Direction

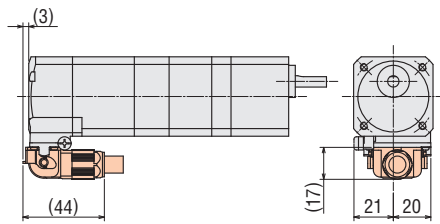

Cable Outlet in Vertical Direction

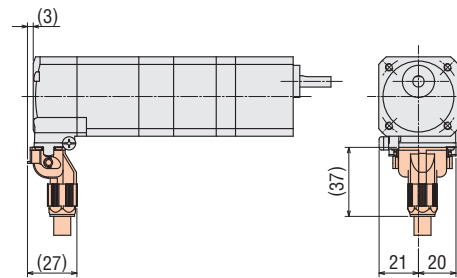

Cable Outlet Opposite to Output Shaft Direction

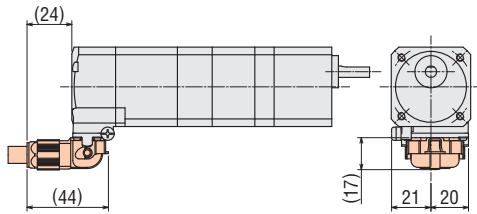

- A number indicating the gear ratio is entered where the box   is located within the product name.
- The shaded   areas are the separately sold connection cables.

Frame Size 60 mm

Connector Direction	Product Name	Gear Ratio	Mass [kg]
Down Side	<b>AZM66MKH-TS</b> <span style="background-color: #cccccc; border: 1px solid black; padding: 0 2px;"> </span>	<b>3.6, 7.2, 10, 20, 30</b>	1.6
Right Side	<b>AZM66MKH-TS</b> <b>R</b> <span style="background-color: #cccccc; border: 1px solid black; padding: 0 2px;"> </span>		
Upper Side	<b>AZM66MKH-TS</b> <b>U</b> <span style="background-color: #cccccc; border: 1px solid black; padding: 0 2px;"> </span>		
Left Side	<b>AZM66MKH-TS</b> <b>L</b> <span style="background-color: #cccccc; border: 1px solid black; padding: 0 2px;"> </span>		

● Mounting Screws: M4×60 P0.7 (4 pieces included)

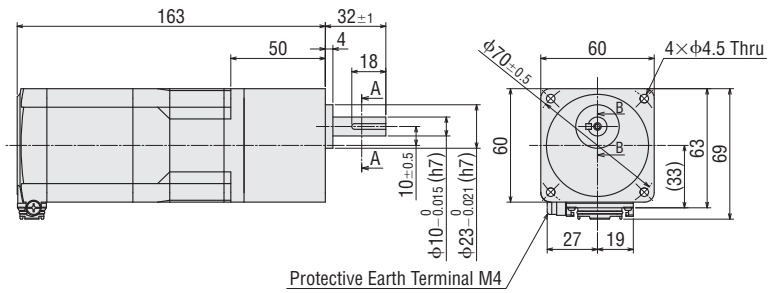

Parallel Key (Included)

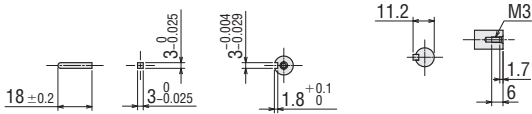

● Connector Direction

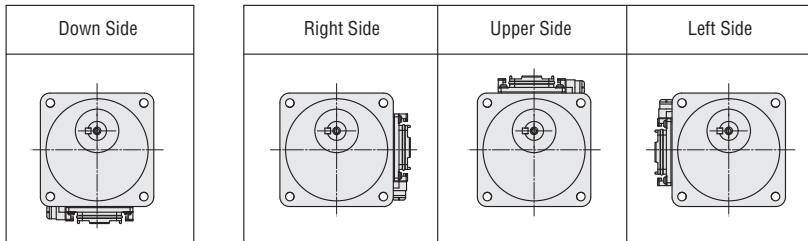

● When the Connection Cable is Attached

Cable Outlet in Output Shaft Direction

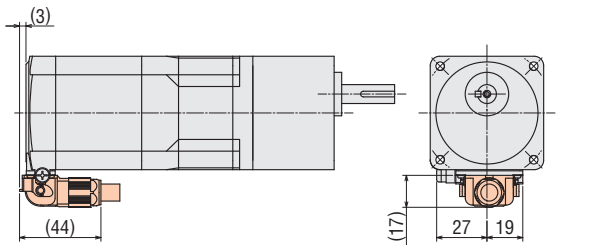

Cable Outlet in Vertical Direction

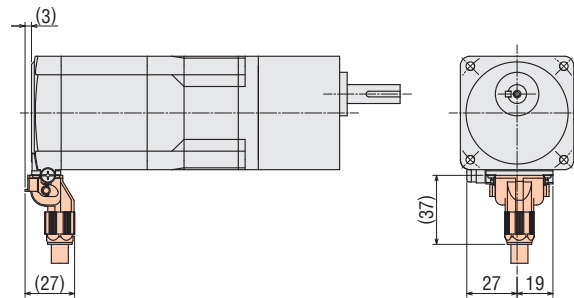

Cable Outlet Opposite to Output Shaft Direction

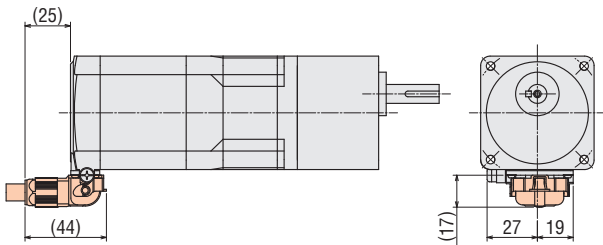

● A number indicating the gear ratio is entered where the box   is located within the product name.  
 ● The shaded   areas are the separately sold connection cables.

◇FC Geared Type

Frame Size 42 mm Connector Direction Upper Side

Product Name	Gear Ratio	Mass [kg]
<b>AZM46AKH-FC</b> <span style="border: 1px solid black; padding: 0 2px;"> </span> <b>UA</b>	<b>7.2, 10, 20, 30</b>	0.75

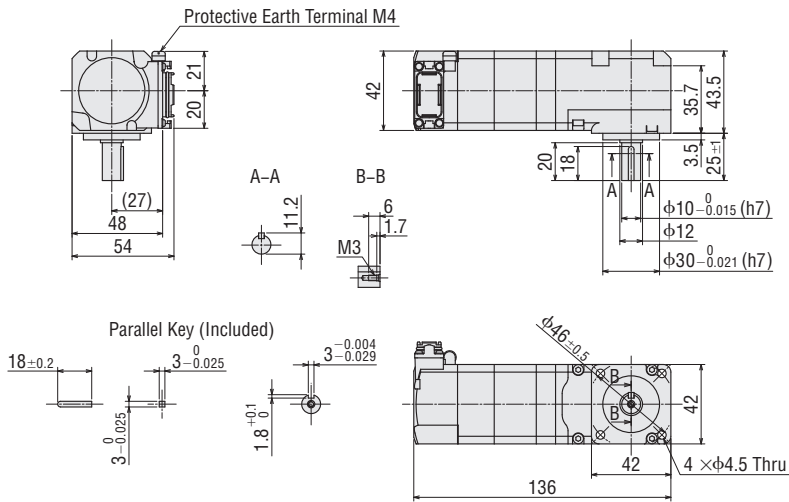

● When the Connection Cable is Attached

Cable Outlet in Output Shaft Direction

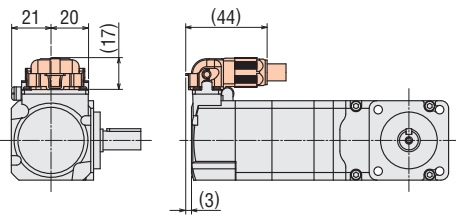

Cable Outlet in Vertical Direction

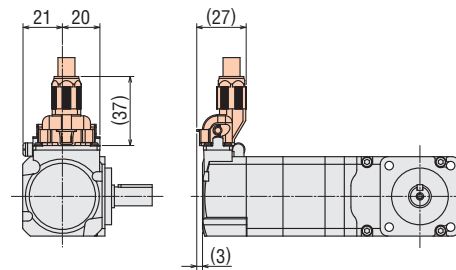

Cable Outlet Opposite to Output Shaft Direction

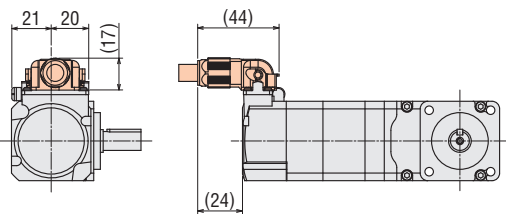

- A number indicating the gear ratio is entered where the box   is located within the product name.
- The shaded  areas are the separately sold connection cables.

AC Input	System Configuration
	Product Line
	Specifications and Characteristics
DC Input	Dimensions
	System Configuration
	Product Line
Cable	Specifications and Characteristics
	Dimensions
	Cable

Frame Size 42 mm Connector Direction Down Side

Product Name	Gear Ratio	Mass [kg]
<b>AZM46AKH-FC</b> <span style="border: 1px solid black; padding: 0 2px;"> </span> <b>DA</b>	<b>7.2, 10, 20, 30</b>	0.75

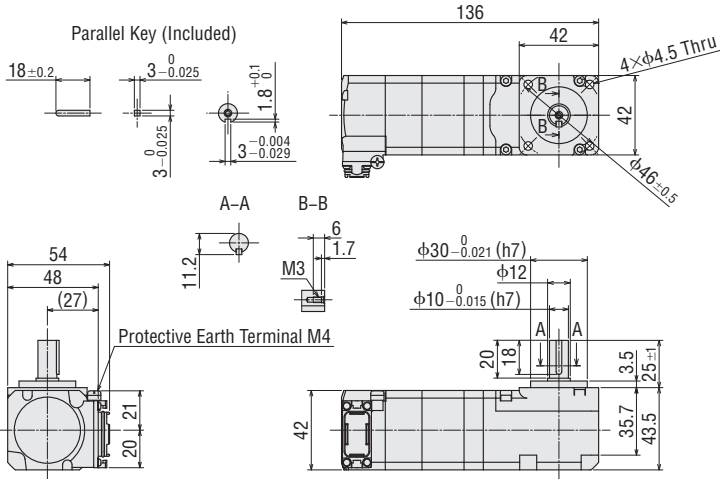

● When the Connection Cable is Attached

Cable Outlet in Output Shaft Direction

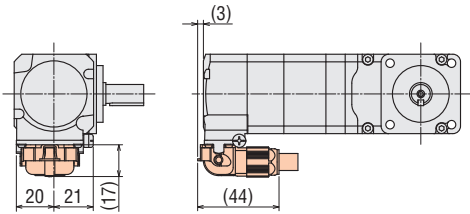

Cable Outlet in Vertical Direction

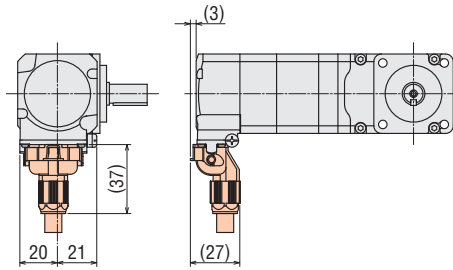

Cable Outlet Opposite to Output Shaft Direction

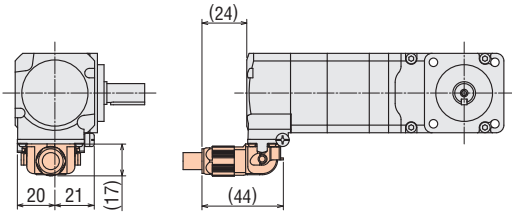

● A number indicating the gear ratio is entered where the box   is located within the product name.  
 ● The shaded orange areas are the separately sold connection cables.



### Frame Size 60 mm Connector Direction Upper Side

Product Name	Gear Ratio	Mass [kg]
<b>AZM66AKH-FC</b> <span style="border: 1px solid black; padding: 0 2px;"> </span> <b>UA</b>	<b>7.2, 10, 20, 30</b>	1.7

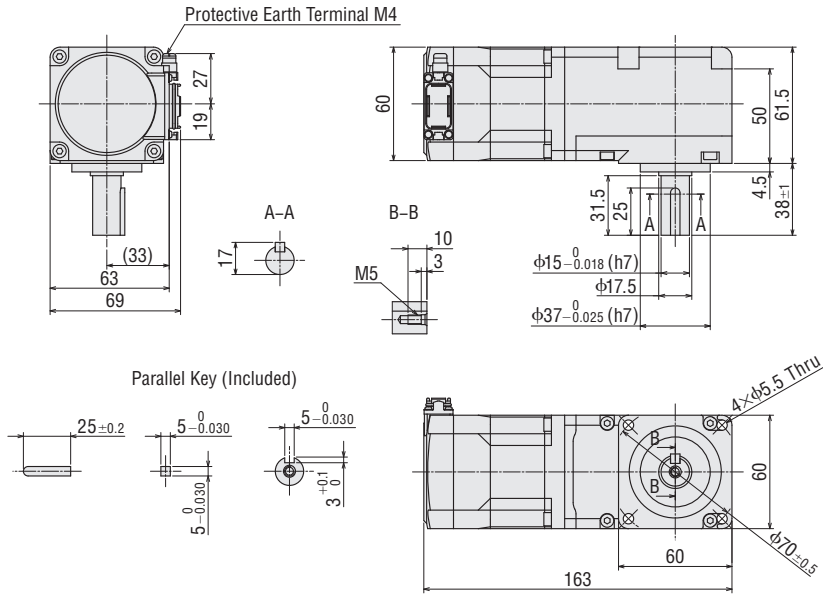

#### ● When the Connection Cable is Attached

Cable Outlet in Output Shaft Direction

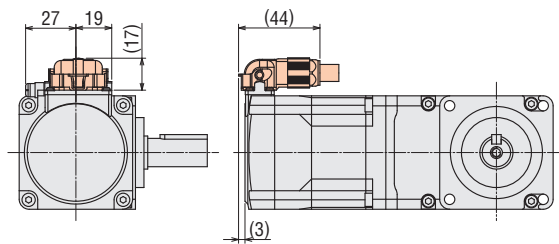

Cable Outlet in Vertical Direction

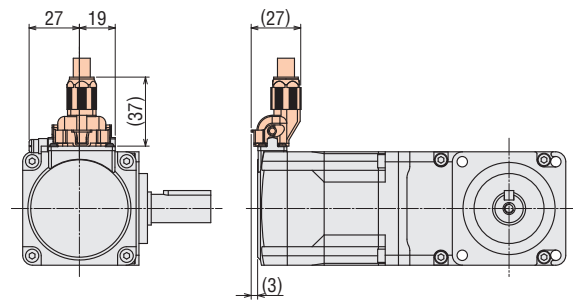

Cable Outlet Opposite to Output Shaft Direction

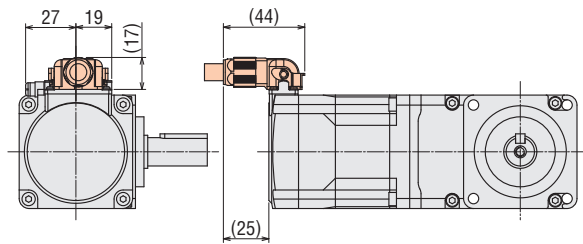

- A number indicating the gear ratio is entered where the box   is located within the product name.
- The shaded  areas are the separately sold connection cables.

AC Input	System Configuration
	Product Line
	Specifications and Characteristics
DC Input	Dimensions
	System Configuration
	Product Line
Cable	Specifications and Characteristics
	Dimensions
	Cable

Frame Size 60 mm Connector Direction Down Side

Product Name	Gear Ratio	Mass [kg]
AZM66AKH-FC <span style="background-color: #cccccc;">  </span> DA	7.2, 10, 20, 30	1.7

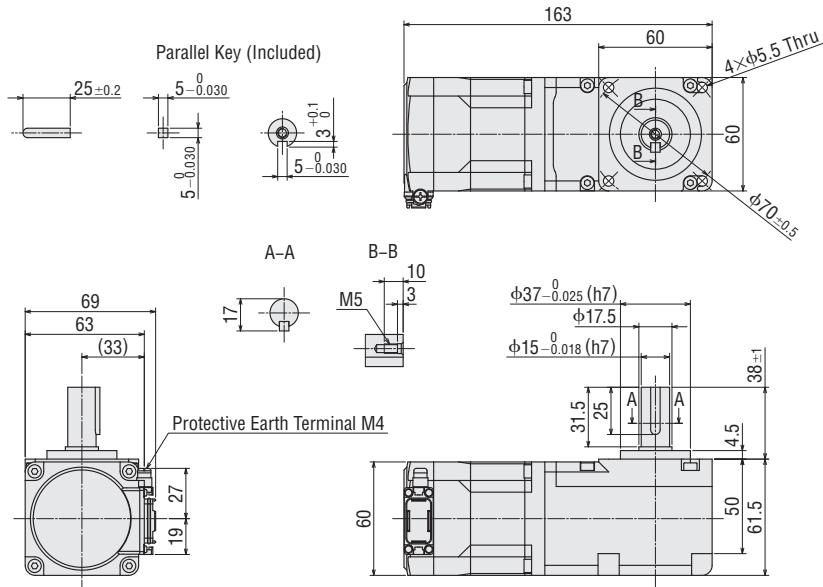

● When the Connection Cable is Attached

Cable Outlet in Output Shaft Direction

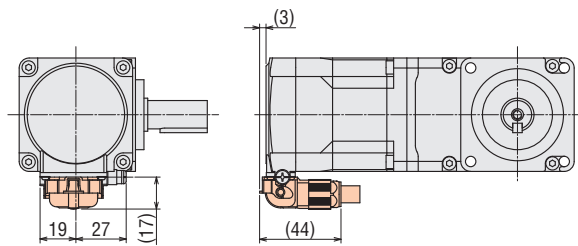

Cable Outlet in Vertical Direction

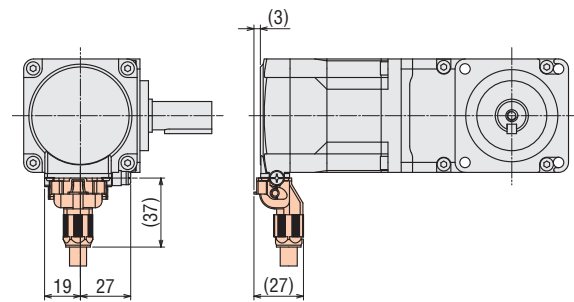

Cable Outlet Opposite to Output Shaft Direction

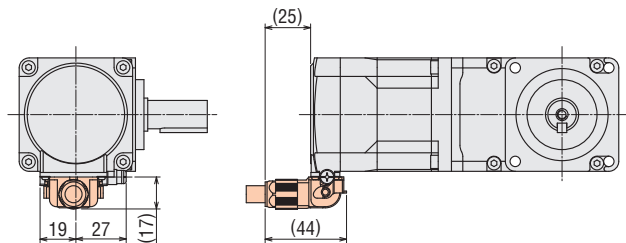

- A number indicating the gear ratio is entered where the box    is located within the product name.
- The shaded    areas are the separately sold connection cables.

◇FC Geared Type with Electromagnetic Brake  
 Frame Size 42 mm Connector Direction Upper Side

Product Name	Gear Ratio	Mass [kg]
<b>AZM46MKH-FC</b> ■ <b>UA</b>	<b>7.2, 10, 20, 30</b>	0.89

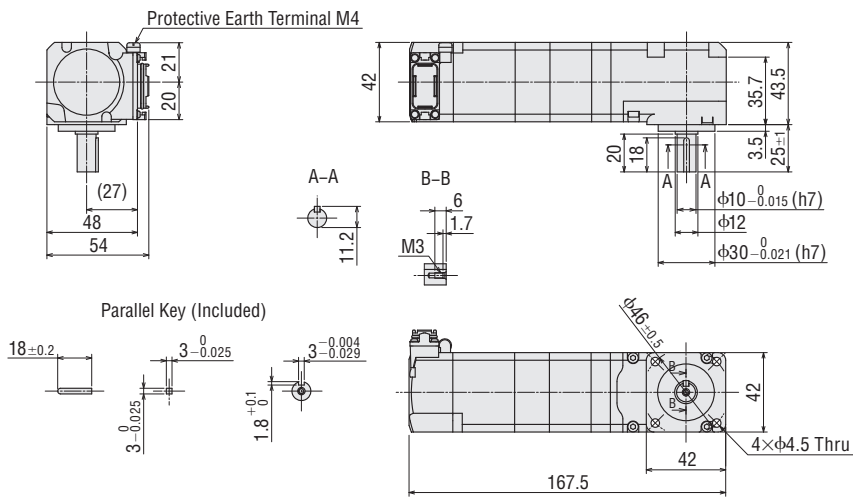

● When the Connection Cable is Attached  
 Cable Outlet in Output Shaft Direction

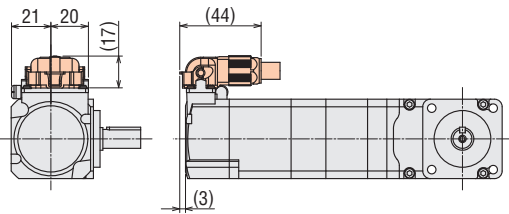

Cable Outlet in Vertical Direction

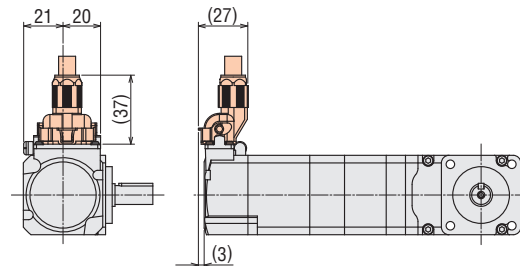

Cable Outlet Opposite to Output Shaft Direction

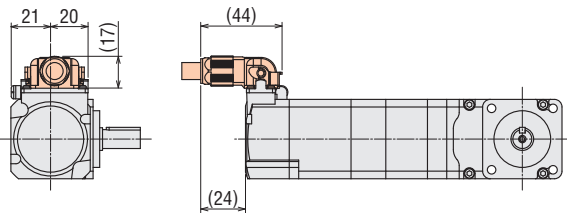

- A number indicating the gear ratio is entered where the box ■ is located within the product name.
- The shaded areas are the separately sold connection cables.

System Configuration	Product Line	Specifications and Characteristics	Dimensions
System Configuration	Product Line	Specifications and Characteristics	Dimensions
System Configuration	Product Line	Specifications and Characteristics	Dimensions

Frame Size 42 mm Connector Direction Down Side

Product Name	Gear Ratio	Mass [kg]
AZM46MKH-FC <span style="border: 1px solid black; padding: 0 2px;"> </span> DA	7.2, 10, 20, 30	0.89

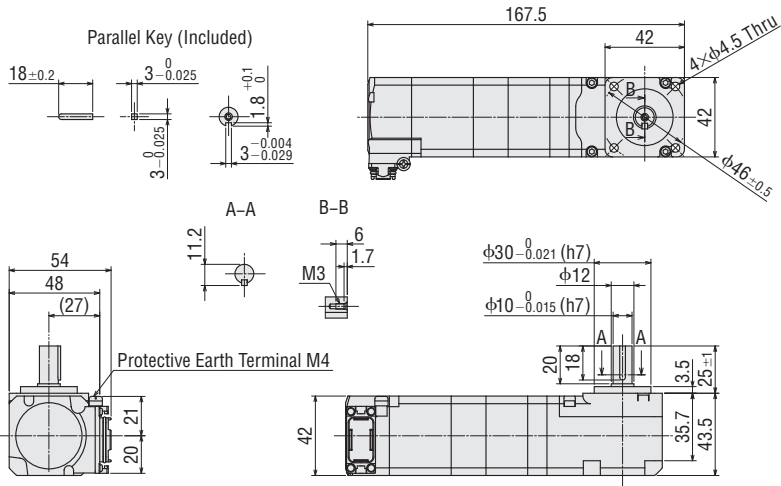

● When the Connection Cable is Attached

Cable Outlet in Output Shaft Direction

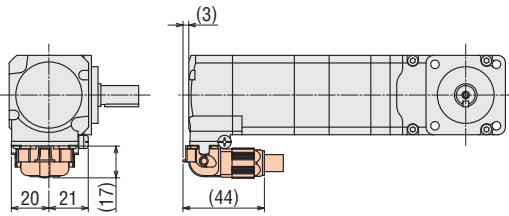

Cable Outlet in Vertical Direction

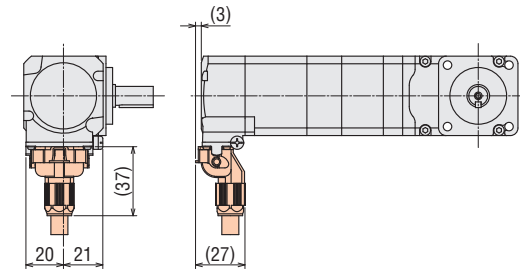

Cable Outlet Opposite to Output Shaft Direction

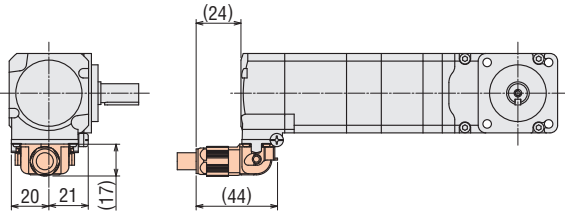

- A number indicating the gear ratio is entered where the box   is located within the product name.
- The shaded  areas are the separately sold connection cables.

Frame Size 60 mm Connector Direction Upper Side

Product Name	Gear Ratio	Mass [kg]
<b>AZM66MKH-FC</b> <span style="border: 1px solid black; padding: 0 2px;"> </span> <b>UA</b>	<b>7.2, 10, 20, 30</b>	2.1

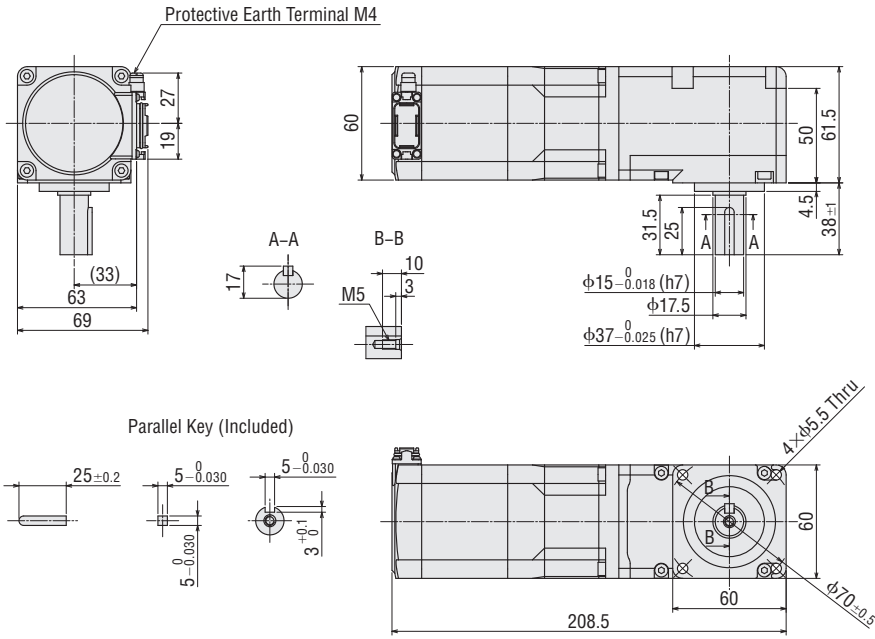

● When the Connection Cable is Attached

Cable Outlet in Output Shaft Direction

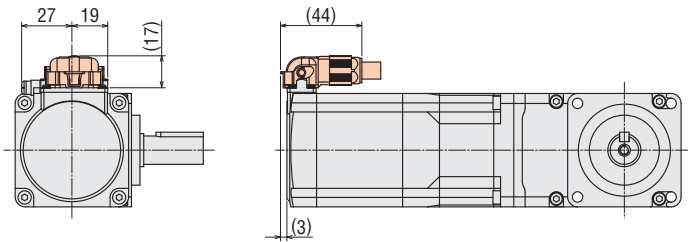

Cable Outlet in Vertical Direction

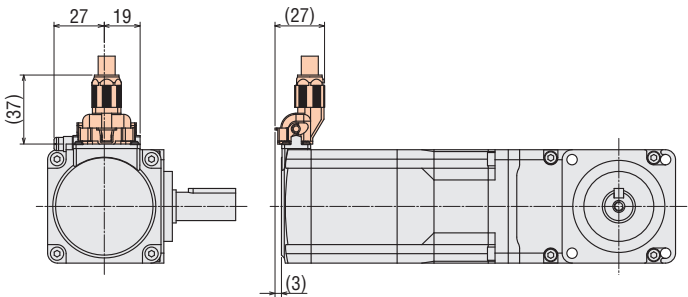

Cable Outlet Opposite to Output Shaft Direction

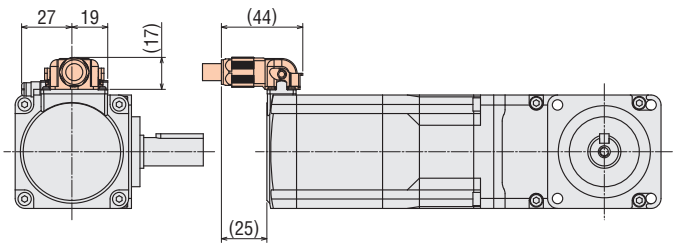

● A number indicating the gear ratio is entered where the box   is located within the product name.  
 ● The shaded  areas are the separately sold connection cables.

Frame Size 60 mm Connector Direction Down Side

Product Name	Gear Ratio	Mass [kg]
AZM66MKH-FC■DA	7.2, 10, 20, 30	2.1

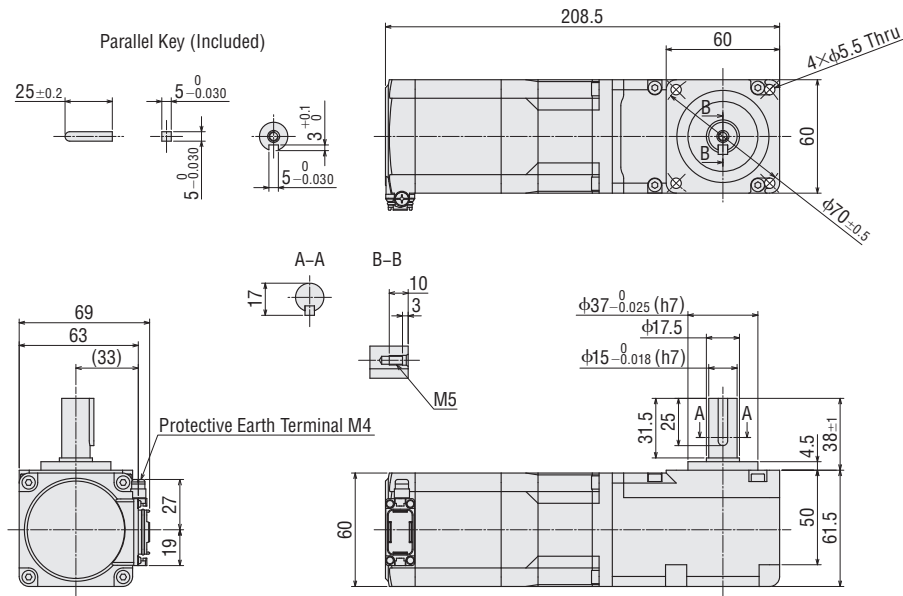

● When the Connection Cable is Attached

Cable Outlet in Output Shaft Direction

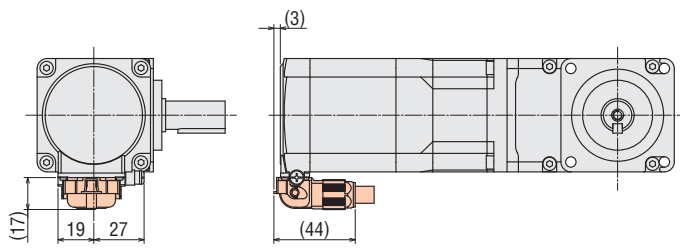

Cable Outlet in Vertical Direction

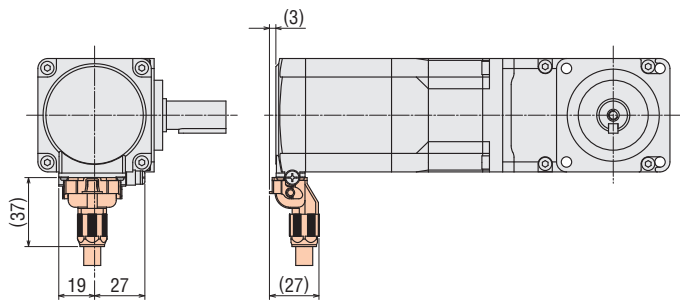

Cable Outlet Opposite to Output Shaft Direction

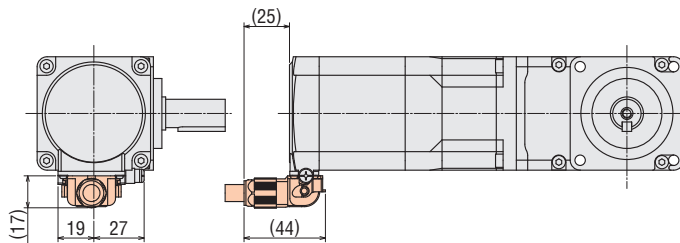

● A number indicating the gear ratio is entered where the box ■ is located within the product name.  
 ● The shaded areas are the separately sold connection cables.

◇ **PS Geared Type**  
**Frame Size 42 mm**

Product Name	Gear Ratio	L	Mass [kg]
<b>AZM46AKH-PS</b> ■	<b>5, 7, 2, 10</b>	103	0.6
	<b>25, 36, 50</b>	126.5	0.75

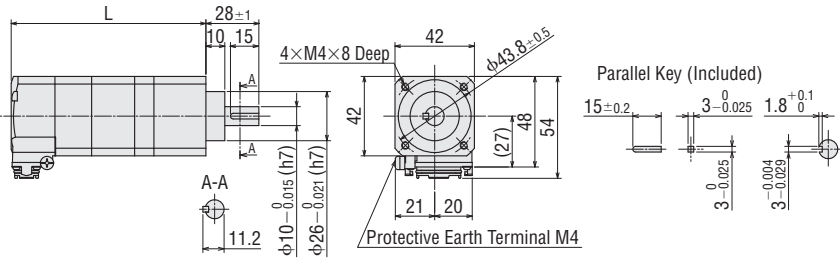

● **When the Connection Cable is Attached**  
**Cable Outlet in Output Shaft Direction**

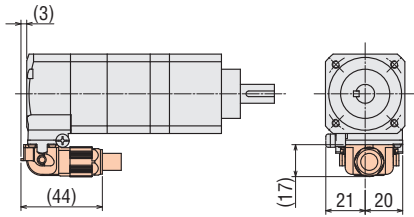

**Cable Outlet in Vertical Direction**

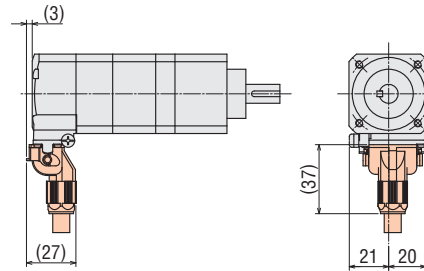

**Cable Outlet Opposite to Output Shaft Direction**

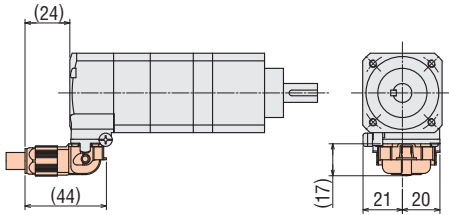

● A number indicating the gear ratio is entered where the box ■ is located within the product name.  
 ● The shaded areas are the separately sold connection cables.

Frame Size 60 mm

Product Name	Gear Ratio	L	Mass [kg]
<b>AZM66AKH-PS</b> ■	<b>5, 7, 2, 10</b>	106.5	1.2
	<b>25, 36, 50</b>	126.5	1.5

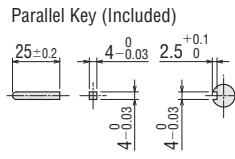
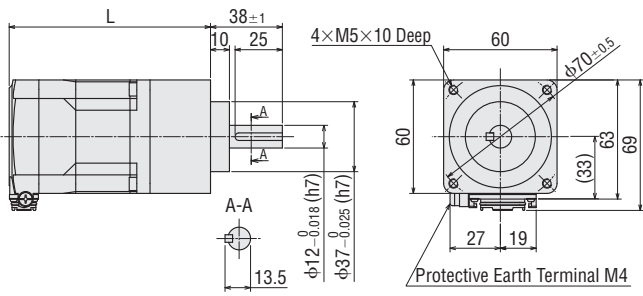

● When the Connection Cable is Attached

Cable Outlet in Output Shaft Direction

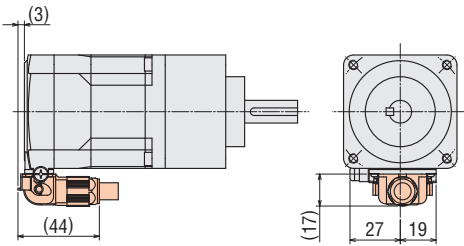

Cable Outlet in Vertical Direction

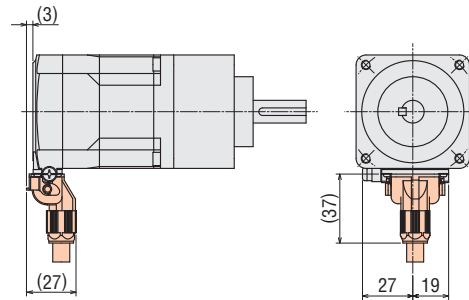

Cable Outlet Opposite to Output Shaft Direction

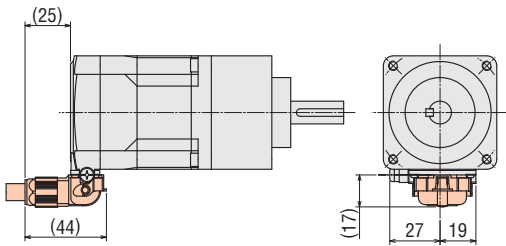

- A number indicating the gear ratio is entered where the box ■ is located within the product name.
- The shaded areas are the separately sold connection cables.



◇ **PS Geared Type with Electromagnetic Brake**  
**Frame Size 42 mm**

Product Name	Gear Ratio	L	Mass [kg]
<b>AZM46MKH-PS</b> <span style="background-color: #cccccc; border: 1px solid black; padding: 0 2px;"> </span>	<b>5. 7. 2. 10</b>	134.5	0.74
	<b>25. 36. 50</b>	157.5	0.89

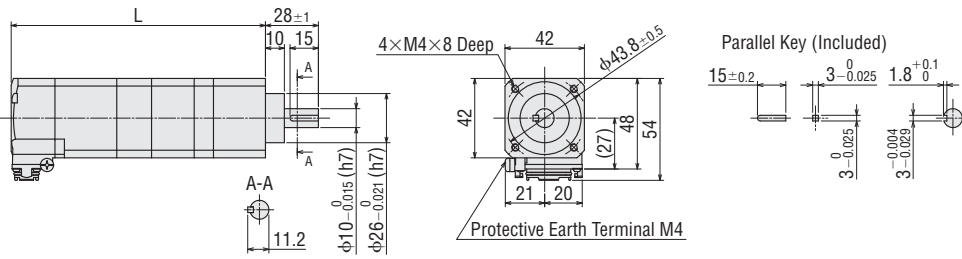

● **When the Connection Cable is Attached**

Cable Outlet in Output Shaft Direction

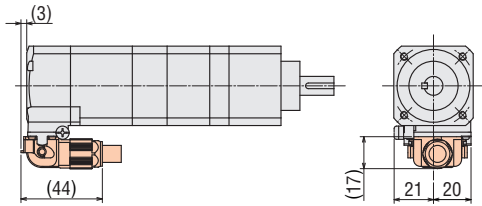

Cable Outlet in Vertical Direction

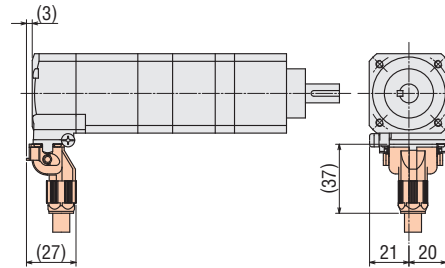

Cable Outlet Opposite to Output Shaft Direction

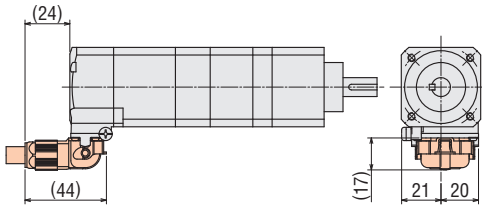

- A number indicating the gear ratio is entered where the box   is located within the product name.
- The shaded   areas are the separately sold connection cables.

System Configuration	AC Input	Specifications and Characteristics	Dimensions	System Configuration	Product Line	Specifications and Characteristics	Dimensions
				DC Input			
							Cable

Frame Size 60 mm

Product Name	Gear Ratio	L	Mass [kg]
<b>AZM66MKH-PS</b> <span style="border: 1px solid black; padding: 0 2px;"> </span>	<b>5, 7.2, 10</b>	152	1.6
	<b>25, 36, 50</b>	172	1.9

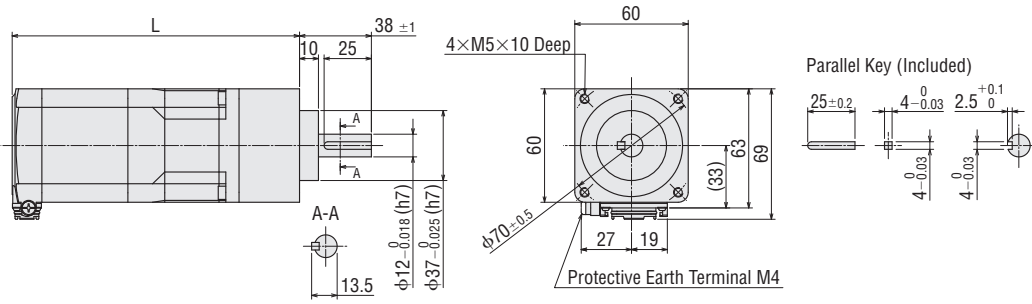

● When the Connection Cable is Attached

Cable Outlet in Output Shaft Direction

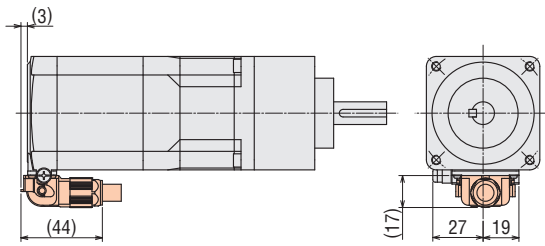

Cable Outlet in Vertical Direction

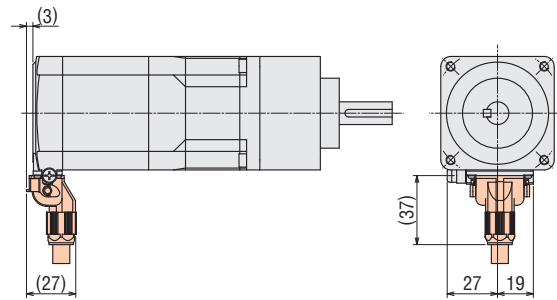

Cable Outlet Opposite to Output Shaft Direction

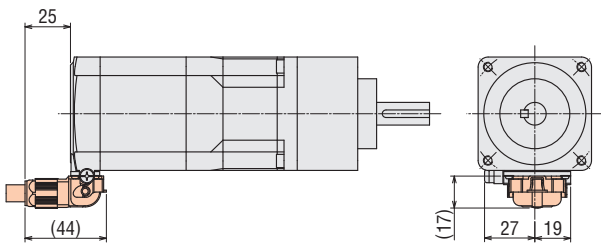

- A number indicating the gear ratio is entered where the box   is located within the product name.
- The shaded  areas are the separately sold connection cables.

◇ Harmonic Geared Type

Frame Size 42 mm

Product Name	Gear Ratio	Mass [kg]
<b>AZM46AKH-HS</b> <span style="border: 1px solid black; padding: 0 2px;"> </span>	<b>50, 100</b>	0.61

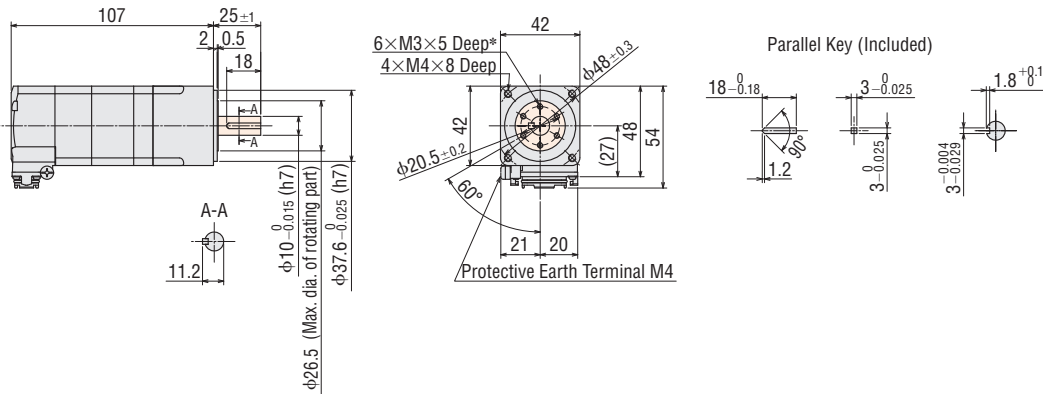

\*The position of the key slot of the output shaft relative to 6×M3 is arbitrary.

● When the Connection Cable is Attached

Cable Outlet in Output Shaft Direction

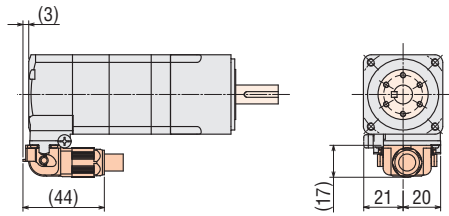

Cable Outlet in Vertical Direction

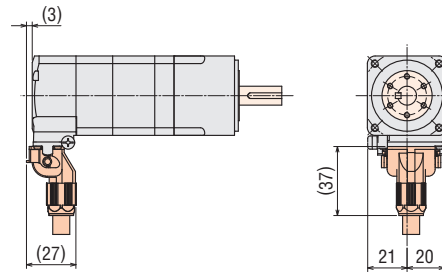

Cable Outlet Opposite to Output Shaft Direction

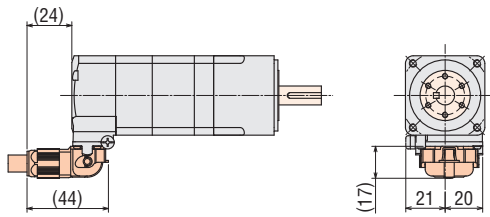

- A number indicating the gear ratio is entered where the box   is located within the product name.
- The shaded  areas in the dimensions are rotating parts.
- The shaded  areas are the separately sold connection cables.

**Frame Size 60 mm**

Product Name	Gear Ratio	Mass [kg]
<b>AZM66AKH-HS</b> <span style="background-color: #cccccc; border: 1px solid black; padding: 0 2px;"> </span>	<b>50, 100</b>	1.3

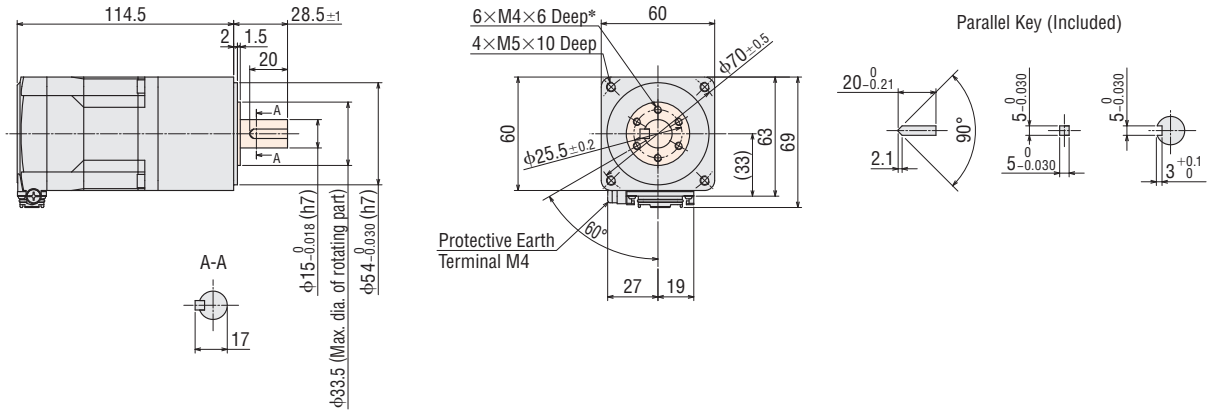

\*The position of the key slot of the output shaft relative to 6×M4 is arbitrary.

**● When the Connection Cable is Attached**

Cable Outlet in Output Shaft Direction

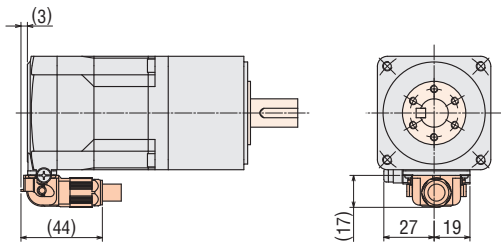

Cable Outlet in Vertical Direction

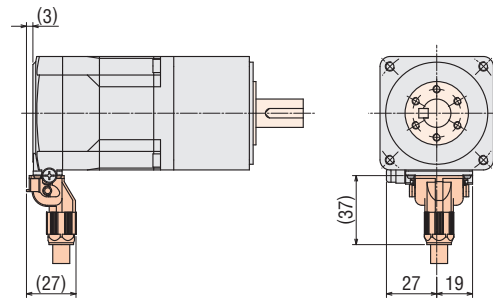

Cable Outlet Opposite to Output Shaft Direction

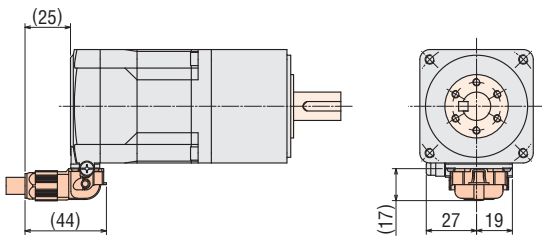

- A number indicating the gear ratio is entered where the box   is located within the product name.
- The shaded   areas in the dimensions are rotating parts.
- The shaded   areas are the separately sold connection cables.

◇ Harmonic Geared Type With Electromagnetic Brake  
Frame Size 42 mm

Product Name	Gear Ratio	Mass [kg]
<b>AZM46MKH-HS</b> <span style="border: 1px solid black; padding: 0 2px;">  </span>	<b>50, 100</b>	0.75

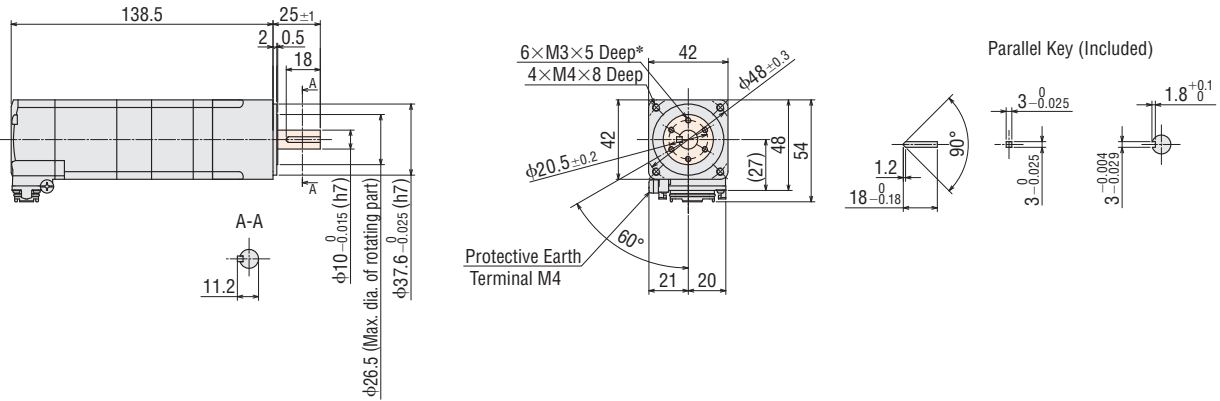

\*The position of the key slot of the output shaft relative to  $6 \times M3$  is arbitrary.

● When the Connection Cable is Attached

Cable Outlet in Output Shaft Direction

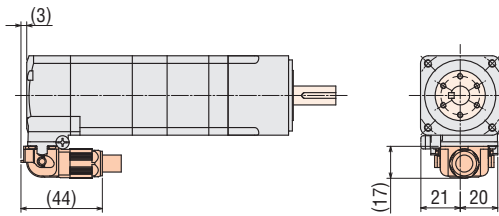

Cable Outlet in Vertical Direction

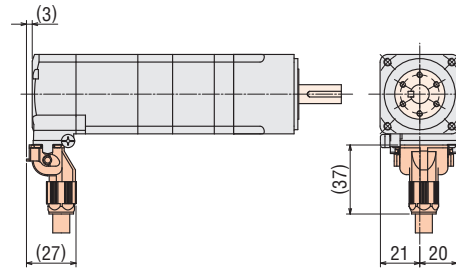

Cable Outlet Opposite to Output Shaft Direction

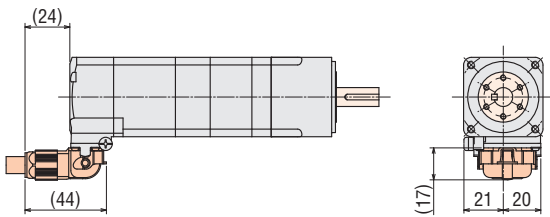

- A number indicating the gear ratio is entered where the box    is located within the product name.
- The shaded  areas in the dimensions are rotating parts.
- The shaded  areas are the separately sold connection cables.

AC Input	System Configuration
	Product Line
	Specifications and Characteristics
DC Input	Dimensions
	System Configuration
	Product Line
Cable	Specifications and Characteristics
	Dimensions
	Cable

## Frame Size 60 mm

Product Name	Gear Ratio	Mass [kg]
<b>AZM66MKH-HS</b> <span style="border: 1px solid black; padding: 0 2px;"> </span>	<b>50, 100</b>	1.7

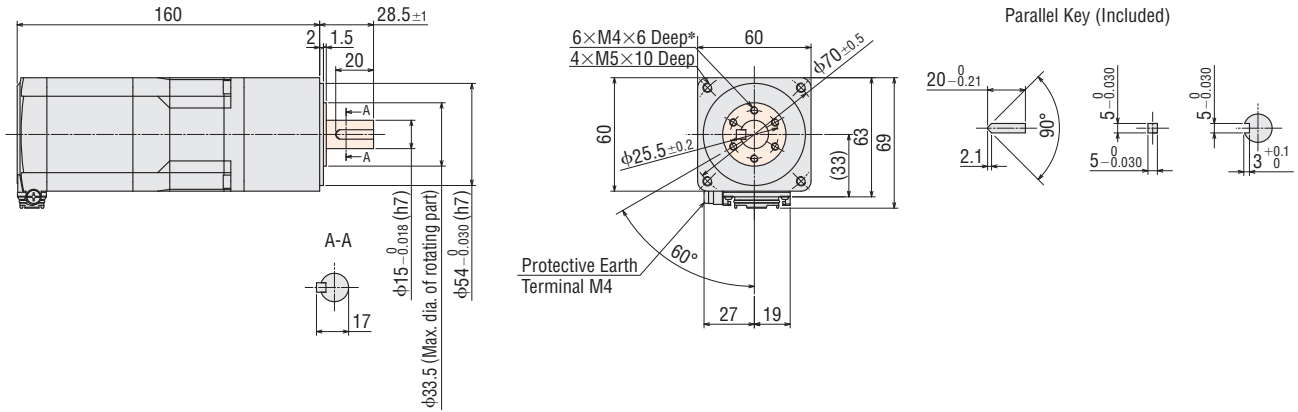

\*The position of the key slot of the output shaft relative to 6×M4 is arbitrary.

### ● When the Connection Cable is Attached

Cable Outlet in Output Shaft Direction

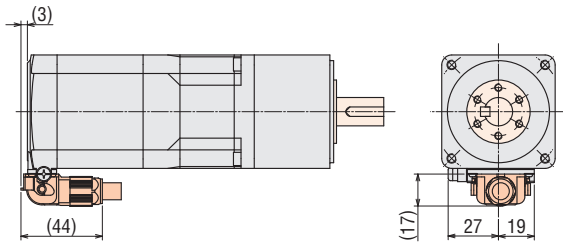

Cable Outlet in Vertical Direction

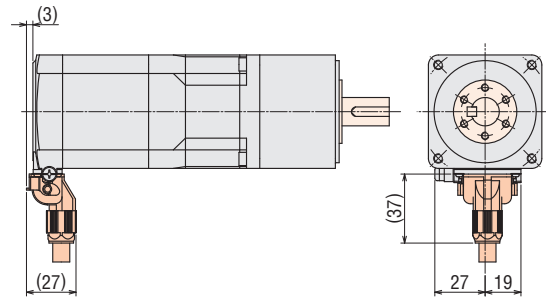

Cable Outlet Opposite to Output Shaft Direction

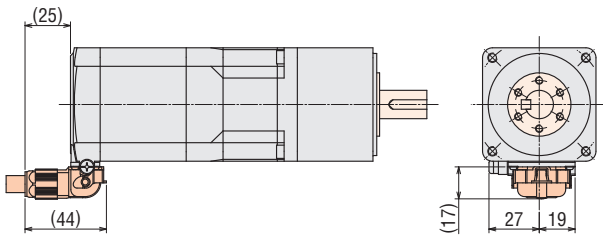

- A number indicating the gear ratio is entered where the box   is located within the product name.
- The shaded  areas in the dimensions are rotating parts.
- The shaded  areas are the separately sold connection cables.

# Cable

## Connection Cables/Flexible Connection Cables

These cables directly connect a motor and driver. Use a flexible connection cable in applications where the cable is bent and flexed.

- Three types of cables with different drawing directions are available. Please select the cable outlet direction needed for the installation.  
(The connection cable will vary depending on the driver used in combination. Check the product name of the driver before selecting the compatible cable.)



Cable Outlet Direction  
Output Shaft Side



Cable Outlet Direction  
Vertical



Cable Outlet Direction  
Opposite Side of Output Shaft

### Product Line

- A letter indicating the driver type is specified where the box   is located in the driver's product name.

### Connection Cable

[Single-axis driver for AC input (Driver product name: **AZD-A**, **AZD-A** , **AZD-C**, **AZD-C** )]

#### ● For Motor/Encoder



Cable Outlet Direction	Length L [m]	Product Name
Output Shaft Direction	1	<b>CCM010Z1AFF</b>
	2	<b>CCM020Z1AFF</b>
	3	<b>CCM030Z1AFF</b>
	5	<b>CCM050Z1AFF</b>
	7	<b>CCM070Z1AFF</b>
Vertical	10	<b>CCM100Z1AFF</b>
	1	<b>CCM010Z1AVF</b>
	2	<b>CCM020Z1AVF</b>
	3	<b>CCM030Z1AVF</b>
	5	<b>CCM050Z1AVF</b>
Opposite to Output Shaft Direction	7	<b>CCM070Z1AVF</b>
	10	<b>CCM100Z1AVF</b>
	1	<b>CCM010Z1ABF</b>
	2	<b>CCM020Z1ABF</b>
	3	<b>CCM030Z1ABF</b>
Opposite to Output Shaft Direction	5	<b>CCM050Z1ABF</b>
	7	<b>CCM070Z1ABF</b>
	10	<b>CCM100Z1ABF</b>

#### ● For Motor/Encoder/Type with Electromagnetic Brake



Cable Outlet Direction	Length L [m]	Product Name
Output Shaft Direction	1	<b>CCM010Z1BFF</b>
	2	<b>CCM020Z1BFF</b>
	3	<b>CCM030Z1BFF</b>
	5	<b>CCM050Z1BFF</b>
	7	<b>CCM070Z1BFF</b>
Vertical	10	<b>CCM100Z1BFF</b>
	1	<b>CCM010Z1BVF</b>
	2	<b>CCM020Z1BVF</b>
	3	<b>CCM030Z1BVF</b>
	5	<b>CCM050Z1BVF</b>
Opposite to Output Shaft Direction	7	<b>CCM070Z1BVF</b>
	10	<b>CCM100Z1BVF</b>
	1	<b>CCM010Z1BBF</b>
	2	<b>CCM020Z1BBF</b>
	3	<b>CCM030Z1BBF</b>
Opposite to Output Shaft Direction	5	<b>CCM050Z1BBF</b>
	7	<b>CCM070Z1BBF</b>
	10	<b>CCM100Z1BBF</b>

[Single-axis driver for DC input (Driver product name: **AZD-K**, **AZD-K** )]

#### ● For Motor/Encoder



Cable Outlet Direction	Length L [m]	Product Name
Output Shaft Direction	0.5	<b>CCM005Z1CFF</b>
	1	<b>CCM010Z1CFF</b>
	2	<b>CCM020Z1CFF</b>
	3	<b>CCM030Z1CFF</b>
	5	<b>CCM050Z1CFF</b>
	7	<b>CCM070Z1CFF</b>
Vertical	10	<b>CCM100Z1CFF</b>
	0.5	<b>CCM005Z1CVF</b>
	1	<b>CCM010Z1CVF</b>
	2	<b>CCM020Z1CVF</b>
	3	<b>CCM030Z1CVF</b>
	5	<b>CCM050Z1CVF</b>
Opposite to Output Shaft Direction	7	<b>CCM070Z1CVF</b>
	10	<b>CCM100Z1CVF</b>
	0.5	<b>CCM005Z1CBF</b>
	1	<b>CCM010Z1CBF</b>
	2	<b>CCM020Z1CBF</b>
	3	<b>CCM030Z1CBF</b>
Opposite to Output Shaft Direction	5	<b>CCM050Z1CBF</b>
	7	<b>CCM070Z1CBF</b>
	10	<b>CCM100Z1CBF</b>

#### ● For Motor/Encoder/Type with Electromagnetic Brake



Cable Outlet Direction	Length L [m]	Product Name
Output Shaft Direction	0.5	<b>CCM005Z1DFF</b>
	1	<b>CCM010Z1DFF</b>
	2	<b>CCM020Z1DFF</b>
	3	<b>CCM030Z1DFF</b>
	5	<b>CCM050Z1DFF</b>
	7	<b>CCM070Z1DFF</b>
Vertical	10	<b>CCM100Z1DFF</b>
	0.5	<b>CCM005Z1DVF</b>
	1	<b>CCM010Z1DVF</b>
	2	<b>CCM020Z1DVF</b>
	3	<b>CCM030Z1DVF</b>
	5	<b>CCM050Z1DVF</b>
Opposite to Output Shaft Direction	7	<b>CCM070Z1DVF</b>
	10	<b>CCM100Z1DVF</b>
	0.5	<b>CCM005Z1DBF</b>
	1	<b>CCM010Z1DBF</b>
	2	<b>CCM020Z1DBF</b>
	3	<b>CCM030Z1DBF</b>
Opposite to Output Shaft Direction	5	<b>CCM050Z1DBF</b>
	7	<b>CCM070Z1DBF</b>
	10	<b>CCM100Z1DBF</b>

[For mini driver (Driver product name: **AZD-KR**)]

- For Motor/Encoder,  
For Motor/Encoder/Electromagnetic Brake



Cable Outlet Direction	Length L [m]	Product Name
Output Shaft Direction	0.2	<b>CCM002Z1EFF</b>
	0.5	<b>CCM005Z1EFF</b>
	1	<b>CCM010Z1EFF</b>
	2	<b>CCM020Z1EFF</b>
	3	<b>CCM030Z1EFF</b>
	5	<b>CCM050Z1EFF</b>
	7	<b>CCM070Z1EFF</b>
Vertical	10	<b>CCM100Z1EFF</b>
	0.2	<b>CCM002Z1EVF</b>
	0.5	<b>CCM005Z1EVF</b>
	1	<b>CCM010Z1EVF</b>
	2	<b>CCM020Z1EVF</b>
	3	<b>CCM030Z1EVF</b>
	5	<b>CCM050Z1EVF</b>
Opposite to Output Shaft Direction	7	<b>CCM070Z1EVF</b>
	10	<b>CCM100Z1EVF</b>
	0.2	<b>CCM002Z1EBF</b>
	0.5	<b>CCM005Z1EBF</b>
	1	<b>CCM010Z1EBF</b>
	2	<b>CCM020Z1EBF</b>
	3	<b>CCM030Z1EBF</b>
Opposite to Output Shaft Direction	5	<b>CCM050Z1EBF</b>
	7	<b>CCM070Z1EBF</b>
	10	<b>CCM100Z1EBF</b>

◇ Flexible Connection Cable

[Single-axis driver for AC input (Driver product name: **AZD-A, AZD-A**, **AZD-C, AZD-C**)]

- For Motor/Encoder



Cable Outlet Direction	Length L [m]	Product Name
Output Shaft Direction	1	<b>CCM010Z1AFR</b>
	2	<b>CCM020Z1AFR</b>
	3	<b>CCM030Z1AFR</b>
	5	<b>CCM050Z1AFR</b>
	7	<b>CCM070Z1AFR</b>
	10	<b>CCM100Z1AFR</b>
Vertical	1	<b>CCM010Z1AVR</b>
	2	<b>CCM020Z1AVR</b>
	3	<b>CCM030Z1AVR</b>
	5	<b>CCM050Z1AVR</b>
	7	<b>CCM070Z1AVR</b>
	10	<b>CCM100Z1AVR</b>
Opposite to Output Shaft Direction	1	<b>CCM010Z1ABR</b>
	2	<b>CCM020Z1ABR</b>
	3	<b>CCM030Z1ABR</b>
	5	<b>CCM050Z1ABR</b>
	7	<b>CCM070Z1ABR</b>
	10	<b>CCM100Z1ABR</b>

- For Motor/Encoder/Type with Electromagnetic Brake



Cable Outlet Direction	Length L [m]	Product Name
Output Shaft Direction	1	<b>CCM010Z1BFR</b>
	2	<b>CCM020Z1BFR</b>
	3	<b>CCM030Z1BFR</b>
	5	<b>CCM050Z1BFR</b>
	7	<b>CCM070Z1BFR</b>
	10	<b>CCM100Z1BFR</b>
Vertical	1	<b>CCM010Z1BVR</b>
	2	<b>CCM020Z1BVR</b>
	3	<b>CCM030Z1BVR</b>
	5	<b>CCM050Z1BVR</b>
	7	<b>CCM070Z1BVR</b>
	10	<b>CCM100Z1BVR</b>
Opposite to Output Shaft Direction	1	<b>CCM010Z1BBR</b>
	2	<b>CCM020Z1BBR</b>
	3	<b>CCM030Z1BBR</b>
	5	<b>CCM050Z1BBR</b>
	7	<b>CCM070Z1BBR</b>
	10	<b>CCM100Z1BBR</b>



[Single-axis driver for DC input (Driver product name: **AZD-K**, **AZD-K**)]



● For Motor/Encoder

Cable Outlet Direction	Length L [m]	Product Name
Output Shaft Direction	0.5	<b>CCM005Z1CFR</b>
	1	<b>CCM010Z1CFR</b>
	2	<b>CCM020Z1CFR</b>
	3	<b>CCM030Z1CFR</b>
	5	<b>CCM050Z1CFR</b>
	7	<b>CCM070Z1CFR</b>
Vertical	10	<b>CCM100Z1CFR</b>
	0.5	<b>CCM005Z1CVR</b>
	1	<b>CCM010Z1CVR</b>
	2	<b>CCM020Z1CVR</b>
	3	<b>CCM030Z1CVR</b>
	5	<b>CCM050Z1CVR</b>
Opposite to Output Shaft Direction	7	<b>CCM070Z1CVR</b>
	10	<b>CCM100Z1CVR</b>
	0.5	<b>CCM005Z1CBR</b>
	1	<b>CCM010Z1CBR</b>
	2	<b>CCM020Z1CBR</b>
	3	<b>CCM030Z1CBR</b>
Opposite to Output Shaft Direction	5	<b>CCM050Z1CBR</b>
	7	<b>CCM070Z1CBR</b>
	10	<b>CCM100Z1CBR</b>



● For Motor/Encoder/Type with Electromagnetic Brake

Cable Outlet Direction	Length L [m]	Product Name
Output Shaft Direction	0.5	<b>CCM005Z1DFR</b>
	1	<b>CCM010Z1DFR</b>
	2	<b>CCM020Z1DFR</b>
	3	<b>CCM030Z1DFR</b>
	5	<b>CCM050Z1DFR</b>
	7	<b>CCM070Z1DFR</b>
Vertical	10	<b>CCM100Z1DFR</b>
	0.5	<b>CCM005Z1DVR</b>
	1	<b>CCM010Z1DVR</b>
	2	<b>CCM020Z1DVR</b>
	3	<b>CCM030Z1DVR</b>
	5	<b>CCM050Z1DVR</b>
Opposite to Output Shaft Direction	7	<b>CCM070Z1DVR</b>
	10	<b>CCM100Z1DVR</b>
	0.5	<b>CCM005Z1DBR</b>
	1	<b>CCM010Z1DBR</b>
	2	<b>CCM020Z1DBR</b>
	3	<b>CCM030Z1DBR</b>
Opposite to Output Shaft Direction	5	<b>CCM050Z1DBR</b>
	7	<b>CCM070Z1DBR</b>
	10	<b>CCM100Z1DBR</b>

[For mini driver (Driver product name: **AZD-KR**)]

- For Motor/Encoder,
- For Motor/Encoder/Electromagnetic Brake

Cable Outlet Direction	Length L [m]	Product Name
Output Shaft Direction	0.5	<b>CCM005Z1EFR</b>
	1	<b>CCM010Z1EFR</b>
	2	<b>CCM020Z1EFR</b>
	3	<b>CCM030Z1EFR</b>
	5	<b>CCM050Z1EFR</b>
	7	<b>CCM070Z1EFR</b>
Vertical	10	<b>CCM100Z1EFR</b>
	0.5	<b>CCM005Z1EVR</b>
	1	<b>CCM010Z1EVR</b>
	2	<b>CCM020Z1EVR</b>
	3	<b>CCM030Z1EVR</b>
	5	<b>CCM050Z1EVR</b>
Opposite to Output Shaft Direction	7	<b>CCM070Z1EVR</b>
	10	<b>CCM100Z1EVR</b>
	0.5	<b>CCM005Z1EBR</b>
	1	<b>CCM010Z1EBR</b>
	2	<b>CCM020Z1EBR</b>
	3	<b>CCM030Z1EBR</b>
Opposite to Output Shaft Direction	5	<b>CCM050Z1EBR</b>
	7	<b>CCM070Z1EBR</b>
	10	<b>CCM100Z1EBR</b>

System Configuration

Product Line

AC Input

Specifications and Characteristics

Dimensions

System Configuration

Product Line

DC Input

Specifications and Characteristics

Dimensions

Cable

● **Dimensions (Unit: mm)**

● An alphabet indicating the driver type is specified where the box ■ is located in the driver's product name.

[Single-axis driver for AC input (Driver product name: **AZD-A, AZD-A■, AZD-C, AZD-C■**)]

● **For Motor/Encoder**

● Cable drawn on output shaft direction, Cable drawn on opposite to output shaft direction

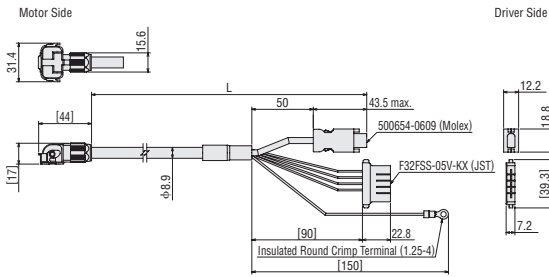

● Cable drawn vertically

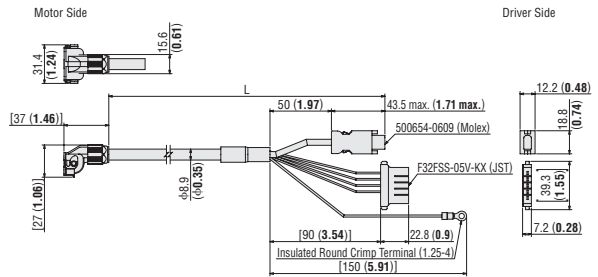

● **For Motor/Encoder/Type with Electromagnetic Brake**

● Cable drawn on output shaft direction, Cable drawn on opposite to output shaft direction

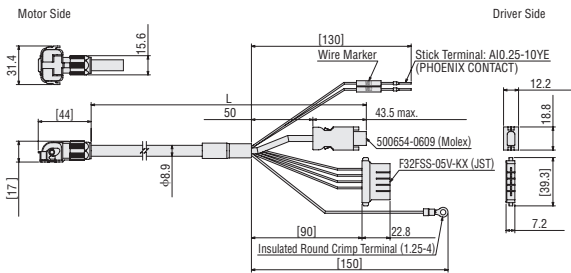

● Cable drawn vertically

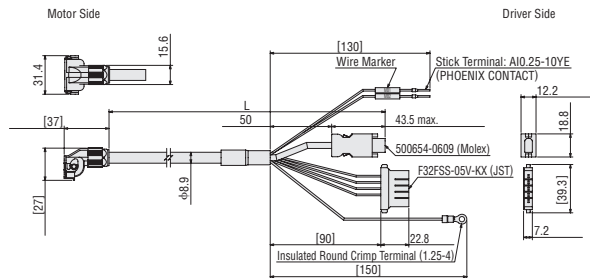

[Single-axis driver for DC input (Driver product name: **AZD-K, AZD-K■**)]

● **For Motor/Encoder**

● Cable drawn on output shaft direction, Cable drawn on opposite to output shaft direction

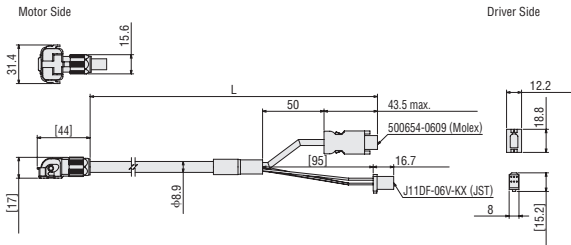

● Cable drawn vertically

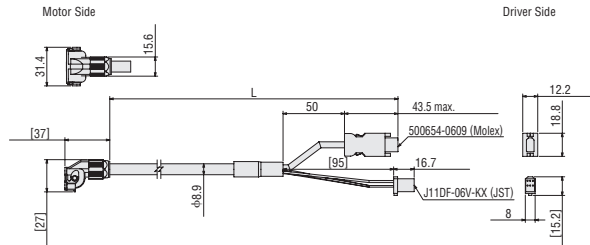

● **For Motor/Encoder/Type with Electromagnetic Brake**

● Cable drawn on output shaft direction, Cable drawn on opposite to output shaft direction

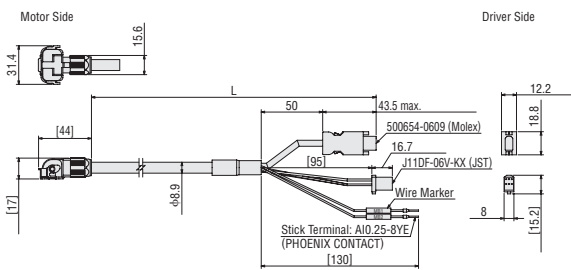

● Cable drawn vertically

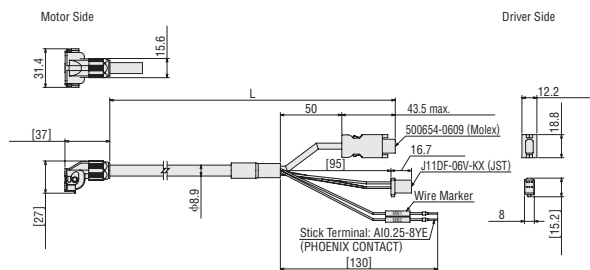

[For mini driver (Driver product name: **AZD-KR■**)]

● **For Motor/Encoder, for Motor/Encoder/Type with Electromagnetic Brake**

● Cable drawn on output shaft direction, Cable drawn on opposite to output shaft direction

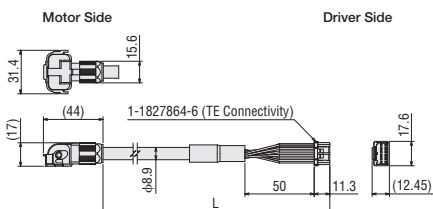

● Cable drawn vertically

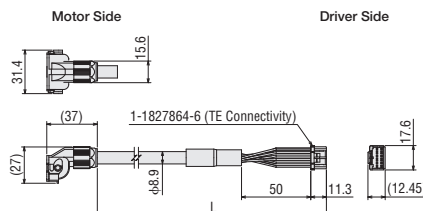

## Extension Cables/Flexible Extension Cables, Driver Side

[For mini driver (Driver product name: **AZD-KR**)]

These are cables to provide an extension between the connection cable and the driver. When using an extension, the total length of the cable must be less than 10 m.

Use the flexible connection cable in applications where the cable is bent and flexed repeatedly.

### Product Line

#### Extension Cable

Length L [m]	Product Name
1	<b>CCM010Z2ADFT</b>
3	<b>CCM030Z2ADFT</b>
5	<b>CCM050Z2ADFT</b>



#### Flexible Extension Cable

Length L [m]	Product Name
1	<b>CCM010Z2ADRT</b>
3	<b>CCM030Z2ADRT</b>
5	<b>CCM050Z2ADRT</b>



### Dimensions (Unit: mm)

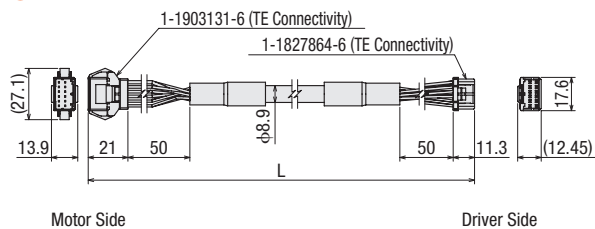

AC Input	System Configuration
	Product Line
	Specifications and Characteristics
DC Input	Dimensions
	System Configuration
	Product Line
Cable	Specifications and Characteristics
	Dimensions
	Product Line

# Orientalmotor

These products are manufactured at plants certified with the international standards **ISO 9001** (for quality assurance) and **ISO 14001** for systems of environmental management).

Specifications are subject to change without notice. This catalogue was published in January 2024.

## **ORIENTAL MOTOR (EUROPA) GmbH**

### **European Headquarters**

Schießstraße 44  
40549 Düsseldorf, Germany  
Tel: 0211 5206700 Fax: 0211 52067099

### **Spanish Office**

C/Caléndula 93 - Ed. E - Miniparc III  
28109 El Soto de La Moraleja,  
Alcobendas (Madrid), Spain  
Tel: +34 918 266 565

## **ORIENTAL MOTOR (UK) LTD.**

### **UK Headquarters**

Unit 5, Faraday Office Park,  
Rankine Road, Basingstoke,  
Hampshire RG24 8AH, U.K.  
Tel: +44 1256 347090 Fax: +44 1256 347099

## **ORIENTAL MOTOR SWITZERLAND AG**

### **Switzerland Headquarters**

Badenerstrasse 13  
5200 Brugg AG, Switzerland  
Tel: +41 56 560 50 45 Fax: +41 56 560 50 47

## **ORIENTAL MOTOR ITALIA s.r.l.**

### **Italy Headquarters**

Via XXV Aprile 5  
20016 Pero (MI), Italy  
Tel: +39 2 93906346 Fax: +39 2 93906348

## **ORIENTAL MOTOR (FRANCE) SARL**

### **France Headquarters**

56, Rue des Hautes Pâtures  
92000 Nanterre, France  
Tel: +33 1 47 86 97 50 Fax: +33 1 47 82 45 16

### **Customer Service Center**

(Support in German & English)

**00800 22 55 66 22 \***

Mon - Thu: 08:00 - 16:30 CET

Friday: 08:00 - 15:00 CET

\*Free Call Europe

[info@orientalmotor.de](mailto:info@orientalmotor.de)

[WWW.ORIENTALMOTOR.EU](http://WWW.ORIENTALMOTOR.EU)

EN | DE | UK | IT | FR | ES