

## Become a robot master in just 3 steps.

### Robot Controller **MRC01**



The MRC01 robot controller supports easy programming and control of in-house designed custom built robots with 3 simple steps: "Initial Setup", "Operation Programming" and "Operational Checking".  
Use the **αSTEP AZ Series** family of products to support your in-house design for improved performance and ease of use.

### ■ Easily Introduce Custom-built Robots to Existing Systems

The connection between the **MRC01** and host system is controlled directly via EtherNet/IP™. Custom-built robots can be added easily, without the need to make major changes to the control system from the existing equipment.

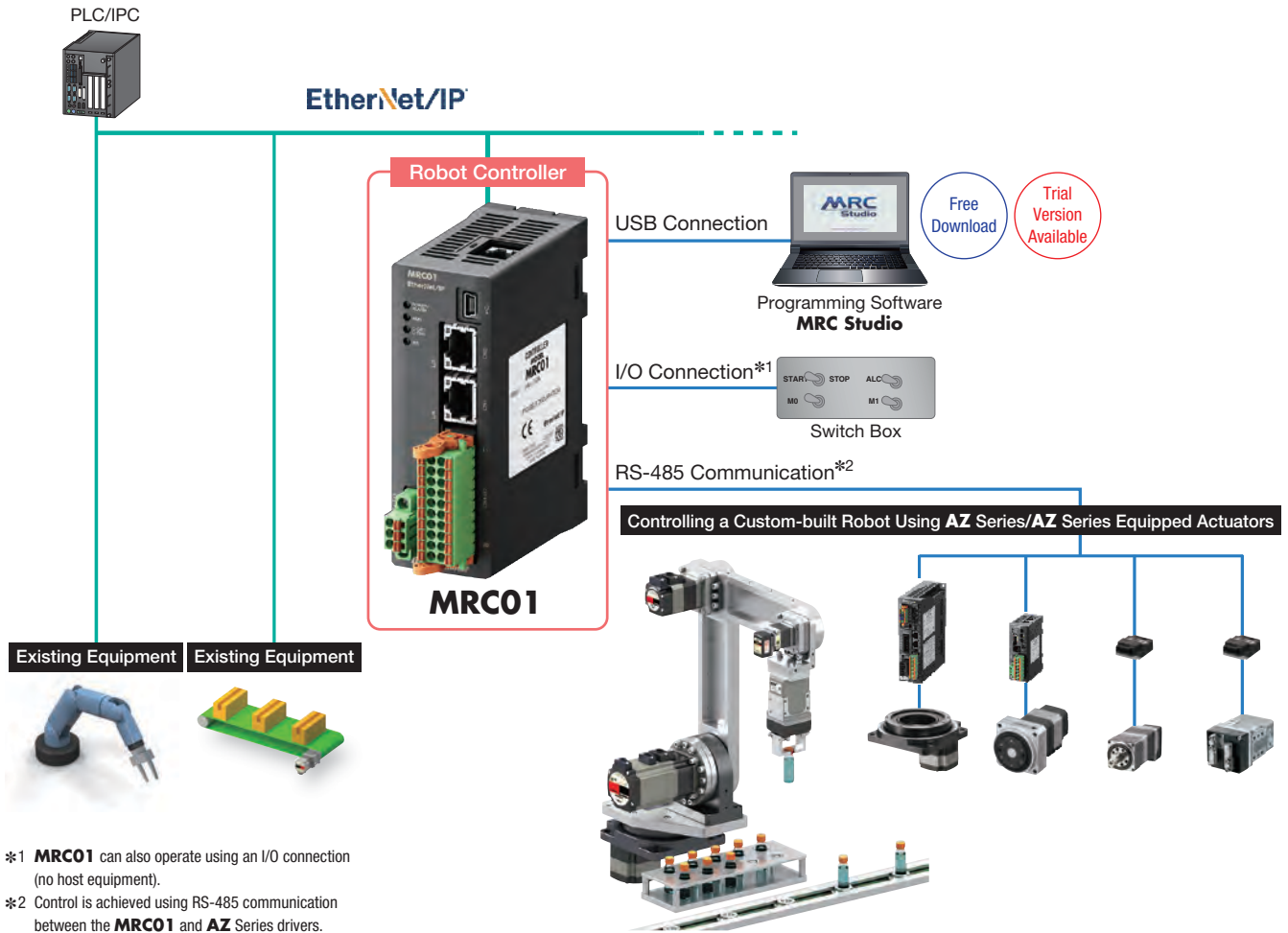

### Vertically Articulated Robot Load Mass 1 kg Standard Cycle Time for Reciprocating Motion (Reference value)

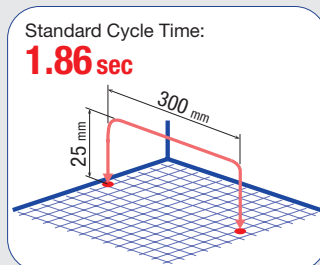
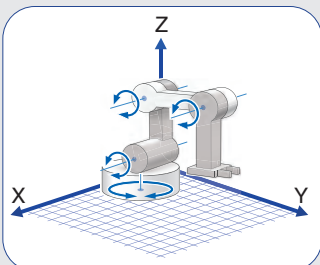

● Video available on the Oriental Motor website  
 → Click here to watch the video "Broad Support for In-House Production of Robots"



# Easy Setup Even for Beginners

The "Programming Software **MRC Studio**" has been prepared to simplify setting up custom-built robots from the initial setting step to the operation programming step.

A trial version of the programming software is also available to allow customers the chance to experience the operation of the **MRC01** before purchase.

\*The **MRC Studio** software and EDS files can be downloaded from the Oriental Motor website.

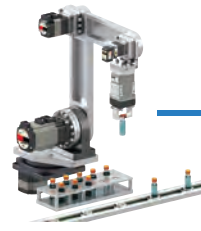

Custom-built Robots Using  
**AZ Series/  
AZ Series Equipped Actuators**



Robot Controller  
**MRC01**



Programming Software  
**MRC Studio**

## Step1. Easy Setup with Step by Step Guidance

Initial settings are made using a wizard to select the robot type and input mechanism information.

By following the guidance instructions while looking at the illustrations, even absolute beginners can quickly set up a robot's initial settings.

### Follow the Steps to Set Up

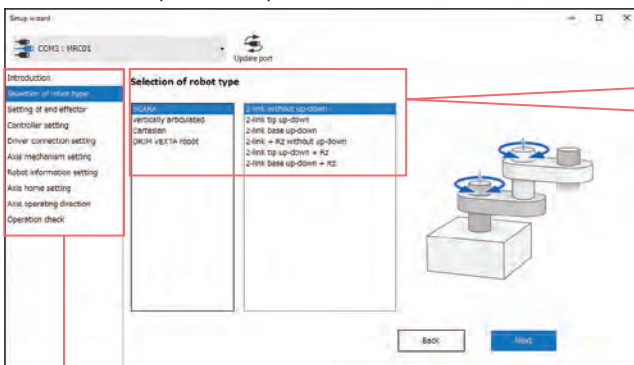

Proceed through initial setting of the robot by following the wizard menu.



### Input Dimensions (Arm length, etc.) With the Help of the Illustration

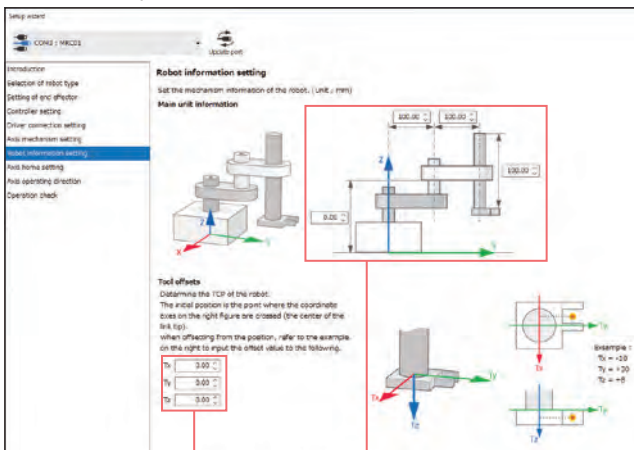

Dimensions are entered directly into the input spaces on the illustrations.

### Select the Robot Type

#### Vertical Articulation

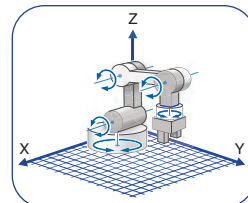

3 link base axis swivels + Rz axis

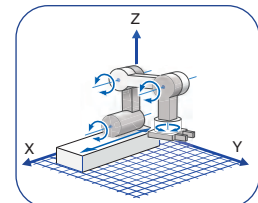

3 link linear motion of base axis + Rz axis

Other: 3 link no base axis; 3 link base axis swivels;  
3 link linear motion of base axis

#### Horizontal Articulation (SCARA)

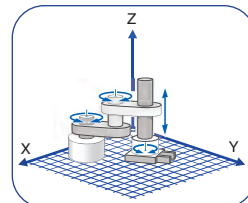

2 link elevating end axis + Rz axis

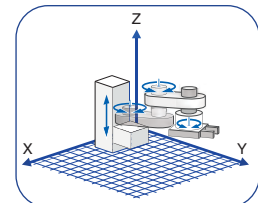

2 link elevating base axis + Rz axis

Other: 2 link no elevating axis; 2 link elevating end axis;  
2 link elevating base axis; 2 link no elevating axis + Rz axis

#### Perpendicular

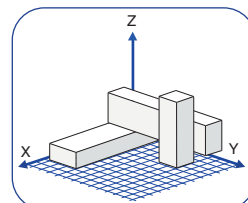

X-Y-Z

Other  
• X-Y  
• X-Z  
• Y-Z

#### ORIM VEXTA Robot

4-axis articulated robot arms from ORIM VEXTA are supported. Please refer to the ORIM VEXTA website for details.

Refer to the operating manual for details on supported robots. Operating manuals can be downloaded from the Oriental Motor website.

## Step2. Say Goodbye to Ladder Logic! Select Items to Program Operation.

Program creation uses a simple command selection format. Programs can be created intuitively, without requiring specialized knowledge such as ladder diagrams. The system supports P to P operation, linear interpolation operation, circular interpolation operation, arch motion and others.

Operating data is executed directly from a host controller via EtherNet/IP.

● Drag and Drop the Required Commands

● Target Position and Speed Setting

Select the necessary action from the "Command" column, drag and drop into the "Sequence" column, then the "Command Setting" column is displayed.

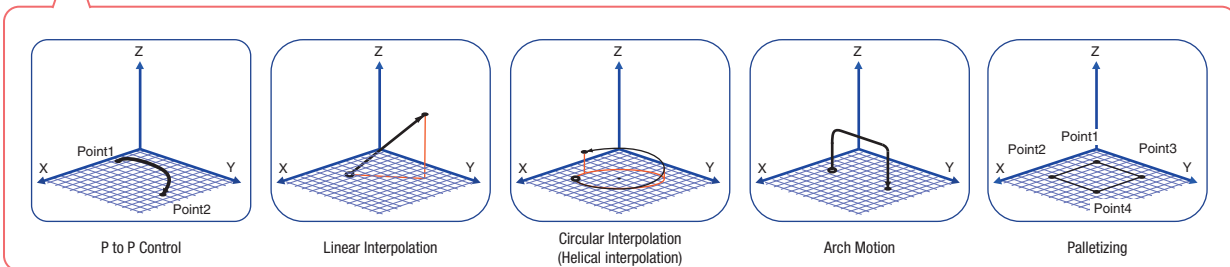
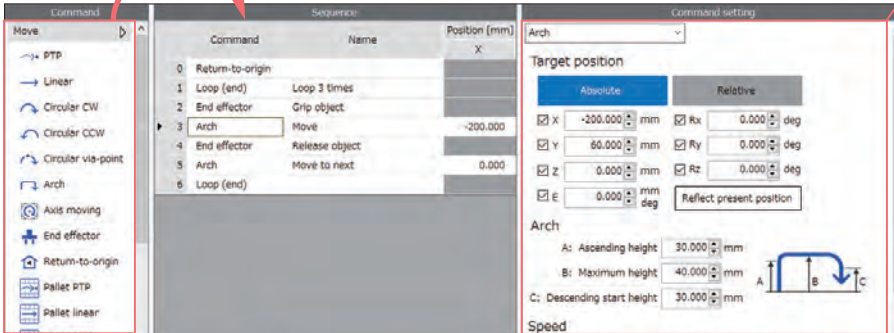

## Step3. Check Operation with an Online 3D Simulator.

The robot's operation program can be checked using a 3D simulator.

The program can be checked easily before the actual robot is activated.

\*Cannot be used offline.

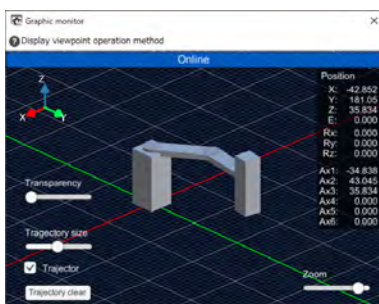

## ■ Applicable Products

This controller can connect to the following **AZ** Series drivers. It can also be connected to an **AZ** Series-equipped Linear & Rotary Actuators.

### AZ Series Drivers

#### ● Built-in Controller Type



Single-Phase 100-120 VAC, 24/48 VDC  
Single-Phase/Three-Phase  
200-240 VAC

#### ● Compact Driver RS-485 Communication Type



24/48 VDC

### AZ Series Motors, AZ Series-Equipped Linear & Rotary Actuators



Motors



Hollow Rotary Actuators  
**DGII** Series



Compact Linear Actuators  
**DR** Series  
**DRS2** Series

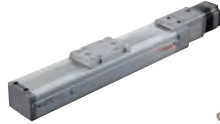

Electric Linear Slides  
**EZS** Series  
**EAS** Series  
**EZSH** Series



Electric Cylinders  
**EAC** Series



Lack and Pinion Systems  
**L** Series



Electric Gripper  
**EH** Series

#### ● AZ Series Brochure

**AZ** Series and **AZ** Series-equipped Linear & Rotary Actuator brochures are available. When selecting products, please also use the brochures.



## Product Line

Product Name
<b>MRC01</b>

## Included

- CN1 Connector (1 pc.)
- CN4 Connector (1 pc.)

## Specifications

### Basic Specifications



Power Supply	Input Voltage	24 VDC $\pm$ 10%
	Input Current	0.2 A
Interface	Field Network	EtherNet/IP
	Control Input	8 points, Photocoupler
	Control Output	8 points, Photocoupler and Open-Collector
RS-485 Communication Specification		Modbus RTU EIA-485 compliance, Straight cable Shielded twisted-pair wire (TIA/EIA-568B CAT5e or greater recommended) is used up to a total extension length of 50 m*1
USB Connector	Specifications	USB 2.0 (Full-Speed)
	Cable	Length: 3 m max. Type: A to mini B
Setting Tool		Programming Software <b>MRC Studio</b>
Number of Control Axes		6 axes max.*2
Robot Model		Horizontal Multi-Joint (2-links), Vertical Multi-Joint (3-links), Right-Angle (2 axes, 3 axes)
Drive Command		P to P, Linear Interpolation, Circular Interpolation, Arc Interpolation, Palette (P to P, Line, Arc)
Monitor		Robot Graphic, Alarm, Information, etc.

\*1 If noise generated by the motor cable or power supply cable causes a problem due to wiring and installation, try shielding the cables or insert ferrite cores.

\*2 Only one robot can be controlled by **MRC01**.

- The number of control axes depends on the robot model. For example, if the robot model is horizontal multi-joint (2-links, up and down of tip axis) and also controls the end effector (1 axis), the number of control axes will be 4 axes.

### EtherNet/IP Specifications

Protocol		EtherNet/IP (CT17 compliance)
Vendor ID		187: Oriental Motor Company
Device Type		43: Generic Device
Transmission Rate		10/100 Mbps (Auto-negotiation)
Communication Mode		Full-duplex/Half-duplex (Auto-negotiation)
Cable Specifications		Shielded Twisted-pair (STP) Cable Straight/Cross, Category 5e or greater is recommended [Total extension length: 50 m max.]
Occupied Byte	Output (Scanner $\rightarrow$ <b>MRC01</b> )	2 to 228 bites
	Input ( <b>MRC01</b> $\rightarrow$ Scanner)	2 to 228 bites
Implicit Communication	Number of Supported Connections	2
	Connection Type	Exclusive Owner, Input Only
	Communication Cycle	10 to 3,200 ms
	Connection Type (Scanner $\rightarrow$ <b>MRC01</b> )	Point-to-Point
	Connection Type ( <b>MRC01</b> $\rightarrow$ Scanner)	Point-to-Point, Multicast
Explicit Communication	Data Reflection Trigger	Cyclic
	Number of Supported Connections	6
IP Address Setting Method	Connection Type	UCMM, Connection
		Parameter, DHCP
Supported Topology		Star, Linear, Ring (Device Level Ring)

### General Specifications

Degree of Protection	IP10
Operating Environment	Ambient Temperature: 0 to +55°C (Non-freezing) Humidity: 85% or less (Non-condensing) Altitude: Max. of 1000 m above sea level Atmosphere: No corrosive gases or dust. The product should not be exposed to water or oil.
Storage Conditions Transportation Conditions	Ambient Temperature: -25 to +70°C (Non-freezing) Humidity: 85% or less (Non-condensing) Altitude: Max. of 3000 m above sea level Atmosphere: No corrosive gases or dust. The product should not be exposed to water or oil.
Insulation Resistance	The measured value is 100 M $\Omega$ or more when a 500 VDC megger is applied between the following locations: · FG Terminal – Power Supply Terminal

#### Note

- When measuring insulation resistance or performing dielectric voltage withstanding test, disconnect the controller and the motor/actuator.

## Standard Cycle Time (Reference Value)

The standard cycle time (reference value) is the time required for reciprocating operation of 25 mm vertically and 300 mm horizontally with a load mass of 1 kg.

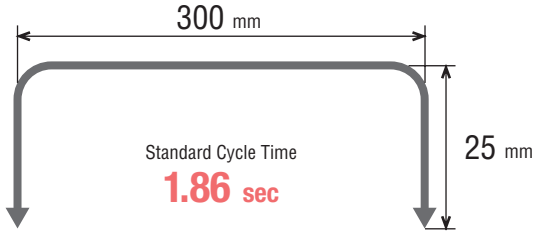

### Note

The standard cycle time (reference value) is the data obtained by our in-house robot measured under the operating conditions where the torque of each axis is sufficient for the load mass. Cycle time depends on your operating conditions.

## Positioning Distance – Positioning Time (Reference Value)

The positioning time (reference) can be checked from the positioning distance.

The positioning time depends on the load mass.

### Horizontal Multi-Joint Robot (2-links, elevating base axis)

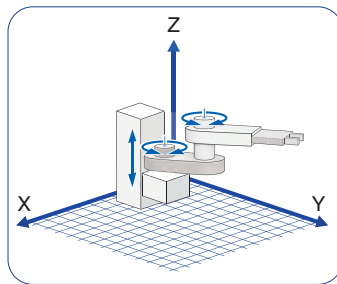
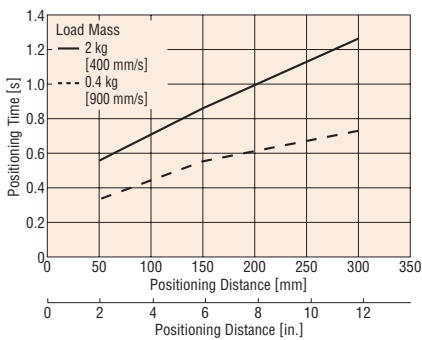

### Vertical Multi-Joint Robot (3-links, turning base axis)

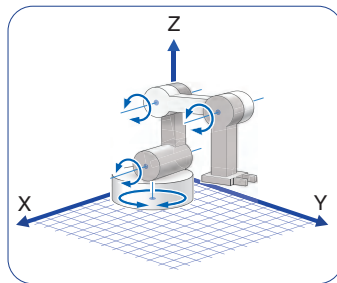
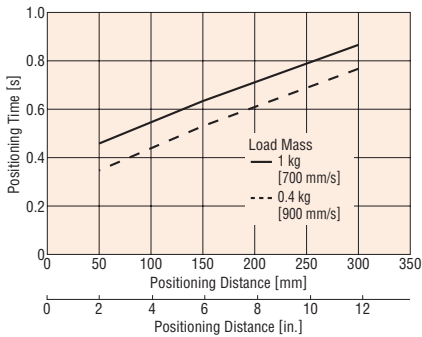

## Dimensions Unit: mm

Product Name	Mass [kg]
<b>MRC01</b>	0.12

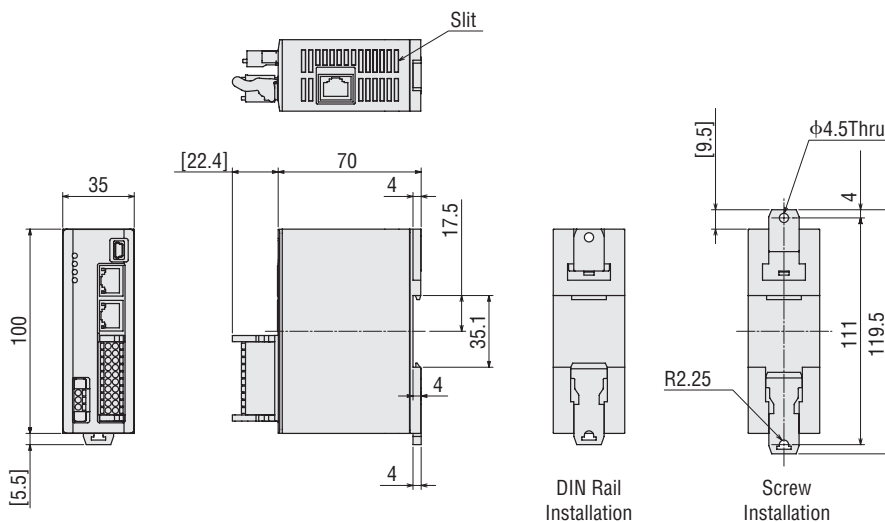

- Included
- Power Supply Connector (CN1)  
Connector: FMC1,5/3-STF3,5  
(Phoenix Contact)
- I/O Signal Connector (CN4)  
Connector: DFMC1,5/10-ST-3,5-LR  
(Phoenix Contact)

# Cables

## RS-485 Communication Cables

These cables are used to connect **MRC01** and **AZ** Series driver.

### Product Line

Product Name	Length L [m]	Applicable Driver
<b>CC001-RS4</b>	0.1	Built-in Controller Type DC Input Driver
<b>CC002-RS4</b>	0.25	Built-in Controller Type AC Input Driver Built-in Controller Type DC Input Driver
<b>CC02FLT6</b>	2	Compact Driver RS-485 Communication Type
<b>CC05FLT6</b>	5	



### Dimensions Unit: mm

**CC001-RS4, CC002-RS4**

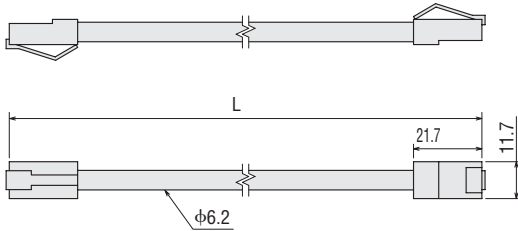

**CC02FLT6, CC05FLT6**

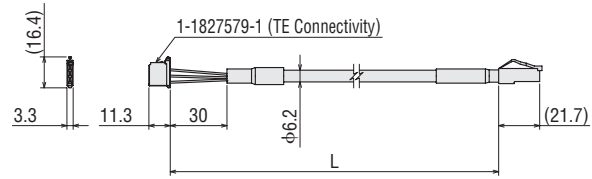

## I/O Signal Cables General-Purpose Type

- Shielded cables
- Loose wires at both ends
- Easy shield grounding with round ground wire terminals
- The number of lead wire cores can be selected to match the functions being used



### Product Line

Product Name	Length L [m]	Number of Lead Wire Cores	Outer Diameter D [mm]	AWG
<b>CC06D005B-1</b>	0.5	6	φ5.4	24
<b>CC06D010B-1</b>	1			
<b>CC06D015B-1</b>	1.5			
<b>CC06D020B-1</b>	2			
<b>CC10D005B-1</b>	0.5	10	φ6.7	
<b>CC10D010B-1</b>	1			
<b>CC10D015B-1</b>	1.5			
<b>CC10D020B-1</b>	2			
<b>CC12D005B-1</b>	0.5	12	φ7.5	
<b>CC12D010B-1</b>	1			
<b>CC12D015B-1</b>	1.5			
<b>CC12D020B-1</b>	2			
<b>CC16D005B-1</b>	0.5	16	φ7.5	
<b>CC16D010B-1</b>	1			
<b>CC16D015B-1</b>	1.5			
<b>CC16D020B-1</b>	2			

### Dimensions Unit: mm

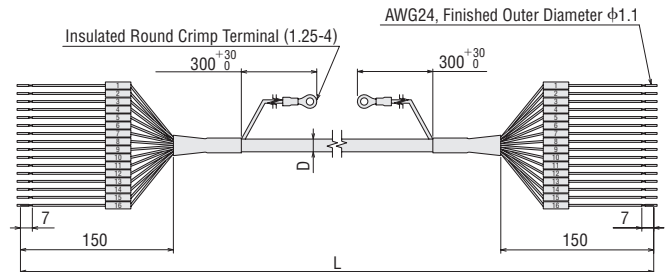

• The figure depicts 16 core wires.

## DC Power Supply Cables

These cables are used to connect **MRC01** and the DC power supply.

### Product Line

Product Name	Length L [m]
<b>CC02D005-3</b>	0.5
<b>CC02D010-3</b>	1
<b>CC02D015-3</b>	1.5
<b>CC02D020-3</b>	2
<b>CC02D050-3</b>	5



### Dimensions Unit: mm

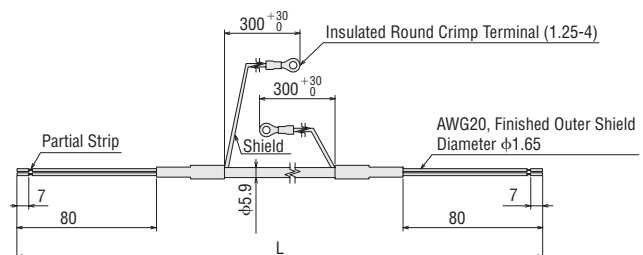

## ■ Dimensions Unit: mm

Product Name	Mass [kg]
<b>AZD-KED</b>	0.18

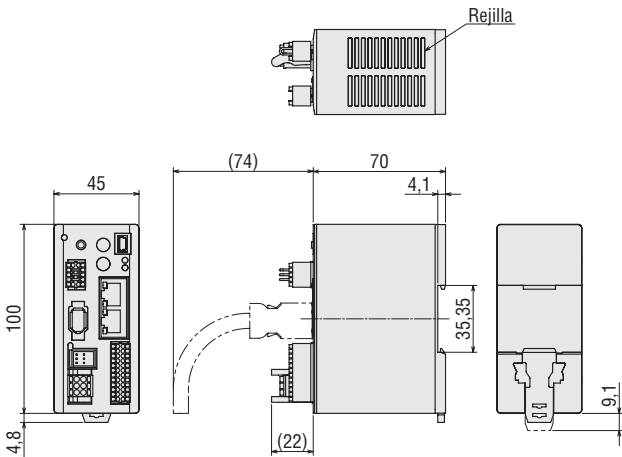

### ● Included

Main Power Supply Connector (CN4)  
Connector: DFMC1,5/3-ST-3,5-LR (Phoenix Contact)

Control Power Supply Connector (CN1)  
Connector: DFMC0,5/5-ST-2,54 (Phoenix Contact)

I/O Signal Connector (CN7)  
Connector: DFMC0,5/12-ST-2,54 (Phoenix Contact)

# Orientalmotor

These products are manufactured at plants certified with the international standards **ISO 9001** (for quality assurance) and **ISO 14001** for systems of environmental management).

Specifications are subject to change without notice. This catalogue was published in January 2024.

## ORIENTAL MOTOR (EUROPA) GmbH

**European Headquarters**  
Schiesstraße 44  
40549 Düsseldorf, Germany  
Tel: 0211 5206700 Fax: 0211 52067099

**Spanish Office**  
C/Caléndula 93 - Ed. E - Miniparc III  
28109 El Soto de La Moraleja,  
Alcobendas (Madrid), Spain  
Tel: +34 918 266 565

## ORIENTAL MOTOR (UK) LTD.

**UK Headquarters**  
Unit 5, Faraday Office Park,  
Rankine Road, Basingstoke,  
Hampshire RG24 8AH, U.K.  
Tel: +44 1256 347090 Fax: +44 1256 347099

## ORIENTAL MOTOR SWITZERLAND AG

**Switzerland Headquarters**  
Badenerstrasse 13  
5200 Brugg AG, Switzerland  
Tel: +41 56 560 50 45 Fax: +41 56 560 50 47

## ORIENTAL MOTOR ITALIA s.r.l.

**Italy Headquarters**  
Via XXV Aprile 5  
20016 Pero (MI), Italy  
Tel: +39 2 93906346 Fax: +39 2 93906348

## ORIENTAL MOTOR (FRANCE) SARL

**France Headquarters**  
56, Rue des Hautes Pâtures  
92000 Nanterre, France  
Tel: +33 1 47 86 97 50 Fax: +33 1 47 82 45 16

### Customer Service Center

(Support in German & English)

**00800 22 55 66 22\***

Mon - Thu: 08:00 - 16:30 CET  
Friday: 08:00 - 15:00 CET

\*Free Call Europe

[info@orientalmotor.de](mailto:info@orientalmotor.de)

[WWW.ORIENTALMOTOR.EU](http://WWW.ORIENTALMOTOR.EU)

EN | DE | UK | IT | FR | ES